

Dell 1230c

Color Laser Printer User's Guide

www.dell.com | support.dell.com



features of your new laser printer

Your new printer is equipped with a number of special features that improve the quality of the documents you print. With the printer, you can:

SPECIAL FEATURES



Print with excellent quality and speed

- You can print in a full range of colors using cyan, magenta, yellow, and black.
- You can print with a resolution of up to 2400 x 600 dpi effective output.
- Your printer prints A4-sized paper at up to 16 ppm, letter-sized paper at up to 17 ppm in gray scale mode and 4 ppm in color mode.

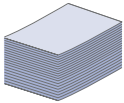

Handle many different types of printable material

- The 150-sheet tray supports plain paper in various sizes, letterhead, envelopes, labels, custom-sized media, postcards, and heavy paper.

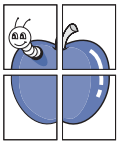

Create professional documents

- Print watermarks. You can customize your documents with words, such as "Confidential". See the Software section.
- Print posters. The text and pictures of each page of your document are magnified and printed across the sheet of paper and can then be taped together to form a poster. See the Software section.
- You can use preprinted forms and letterhead with plain paper. See the Software section.



Save time and money

- To save paper, you can print multiple pages on one single sheet of paper.
- This printer automatically conserves electricity by substantially reducing power consumption when not in use.



Print in various environments

- You can print with Windows 2000 and Windows XP/2003/Vista as well as Macintosh systems.
- Your printer is equipped with a USB interface.



ABOUT THIS USER'S GUIDE

This user's guide provides information about basic understanding of the printer as well as detailed explanation on each step during the actual usage. Both novice users and professional users can refer to this guide for installing and using the printer.

Some terms in this guide are used interchangeably, as below:

- Document is synonymous with original.
- Paper is synonymous with media, or print media.

Following table offers the conventions of this guide:

CONVENTION	DESCRIPTION	EXAMPLE
Bold	Used for texts on the display or actual prints on the printer.	Start
Note	Used to provide additional information or detailed specification of the printer function and feature.	 The date format may differ from country to country
Caution	Used to give users information to protect the printer from possible mechanical damage or malfunction.	 Do not touch the green underside of the toner cartridge.
Footnote	Used to provide more detailed information on certain words or a phrase.	a. pages per minute
(See page 1 for more information)	Used to guide users to the reference page for the additional detailed information.	(See page 1 for more information)

FINDING MORE INFORMATION



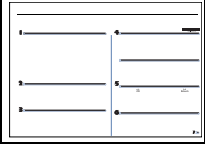
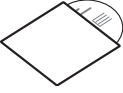
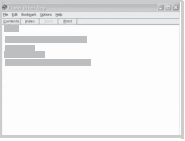







You can find information for setting up and using your printer from the following resources, either as a print-out or onscreen.

<p>Quick Install Guide</p> 	<p>Provides information on setting up your printer and this requires that you follow the instructions in the guide to prepare the printer.</p>
<p>Online User's Guide</p> 	<p>Provides you with step-by-step instructions for using your printer's full features, and contains information for maintaining your printer, troubleshooting, and installing accessories. This user's guide also contains a Software section to provide you with information on how to print documents with your printer in various operating systems, and how to use the included software utilities.</p> <p>Note You can access the user's guide in other languages from the Manual folder on the printer software CD.</p>
<p>Printer Driver Help</p> 	<p>Provides you with help information on printer driver properties and instructions for setting up the properties for printing. To access a printer driver help screen, click Help from the printer properties dialog box.</p>
<p>website</p>	<p>If you have Internet access, you can get help, support, printer drivers, manuals, and order information from the Dell website www.dell.com and support.dell.com.</p>















safety information

IMPORTANT SAFETY SYMBOLS AND PRECAUTIONS

What the icons and signs in this user's guide mean:

 WARNING	Hazards or unsafe practices that may result in severe personal injury or death.
 CAUTION	Hazards or unsafe practices that may result in minor personal injury or property damage.
 CAUTION	To reduce the risk of fire, explosion, electric shock, or personal injury when using your laser Multi-Function Printer(MFP), follow these basic safety precautions:
	Do NOT attempt.
	Do NOT disassemble.
	Do NOT touch.
	Follow directions explicitly.
	Unplug the power plug from the wall socket.
	Ensure the printer is grounded to prevent electric shock.
	Call the service center for help.

These warning signs are here to prevent injury to you and others. Follow them explicitly. After reading this section, keep it in a safe place for future reference.

-  1. Read and understand all instructions.
-  2. Use common sense whenever operating electrical appliances.
-  3. Follow all warnings and instructions marked on the printer and in the literature accompanying the printer.
-  4. If an operating instruction appears to conflict with safety information, heed the safety information. You may have misunderstood the operating instruction. If you cannot resolve the conflict, contact your sales or service representative for assistance.
-  5. Unplug the printer from the AC wall socket and/or telephone jack before cleaning. Do not use liquid or aerosol cleaners. Use only a damp cloth for cleaning.
-  6. Do not place the printer on an unstable cart, stand or table. It may fall, causing serious damage.
-  7. Your printer should never be placed on, near or over a radiator, heater, air conditioner or ventilation duct.
-  8. Do not allow anything to rest on the power. Do not place your printer where the cords will be abused by persons walking on them.
-  9. Do not overload wall outlets and extension cords. This can diminish performance, and may result in the risk of fire or electric shock.
-  10. Do not allow pets to chew on the AC power, telephone or computer interface cords.
-  11. Never push objects of any kind into the printer through case or cabinet openings. They may touch dangerous voltage points, creating a risk of fire or shock. Never spill liquid of any kind onto or into the printer.
-  12. To reduce the risk of electric shock, do not disassemble the printer. Take it to a qualified service technician when repair work is required. Opening or removing covers may expose you to dangerous voltages or other risks. Incorrect reassembly could cause electric shock when the unit is subsequently used.



13. Unplug the printer from the telephone jack, computer and AC wall outlet and refer servicing to qualified service personnel under the following conditions:

- When any part of the power cord, plug or connecting cable is damaged or frayed.
- If liquid has been spilled into the printer.
- If the printer has been exposed to rain or water.
- If the printer does not operate properly after instructions have been followed.
- If the printer has been dropped, or the cabinet appears damaged.
- If the printer exhibits a sudden and distinct change in performance.



14. Adjust only those controls covered by the operating instructions. Improper adjustment of other controls may result in damage, and may require extensive work by a qualified service technician to restore the printer to normal operation.



15. Avoid using this printer during a lightning storm. There may be a remote risk of electric shock from lightning. If possible, unplug the AC power and telephone cord for the duration of the lightning storm.

16. The Power cord supplied with your printer should be used for safe operation. If you are using a cord which is longer than 2 m with 110 V printer, then it should be 16 AWG^a or bigger.

17. Use only No.26 AWG or larger telephone line cord.



18. SAVE THESE INSTRUCTIONS

a. AWG: American Wire Gauge

	2	Features of your new laser printer
	5	Safety information
INTRODUCTION	10	Printer overview
	10	Front view
	10	Rear view
	11	Control panel overview
	12	Understanding the control panel
	12	LEDs
	12	Stop button
	13	Supplied software
	13	Printer driver features
	13	Printer driver
GETTING STARTED	14	Setting up the hardware
	14	Printing a demo page
	14	System requirements
	14	Microsoft® Windows®
	15	Macintosh
	15	Installing the software
	16	printer's basic settings
	16	Altitude adjustment
	16	Using the save modes
	16	Auto continue
SELECTING AND LOADING PRINT MEDIA	17	Selecting print media
	18	Specifications on print media
	19	Guidelines for special print media
	20	Changing the size of the paper in the paper tray
	22	Printing on special print materials
	22	Adjusting the output support
	22	Setting the paper size and type
BASIC PRINTING	23	Printing a document
	23	Canceling a print job
MAINTENANCE	24	Printing reports
	24	Cleaning your printer
	24	Cleaning the outside
	24	Cleaning the inside
	26	Maintaining the cartridge
	26	Toner cartridge storage
	26	Expected cartridge life
	26	Redistributing toner
	27	Replacing the toner cartridge
	28	Replacing the Imaging Unit
	29	Replacing the waste toner container
	30	Maintenance parts

contents

TROUBLESHOOTING	31	Tips for avoiding paper jams
	31	Clearing paper jams
	33	Solving other problems
	33	Paper feeding
	33	Printing problems
	34	Printing quality problems
	37	Common Windows problems
	37	Common Macintosh problems

ORDERING SUPPLIES AND ACCESSORIES	38	Supplies
	38	How to purchase

SPECIFICATIONS	39	General specifications
	40	Printer specifications

GLOSSARY	41
-----------------	-----------

INDEX	45
--------------	-----------

introduction

These are the main components of your printer:

This chapter includes:

- Printer overview
- Control panel overview
- Understanding the control panel
- Supplied software
- Printer driver features

PRINTER OVERVIEW

Front view

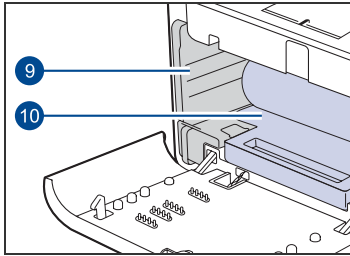
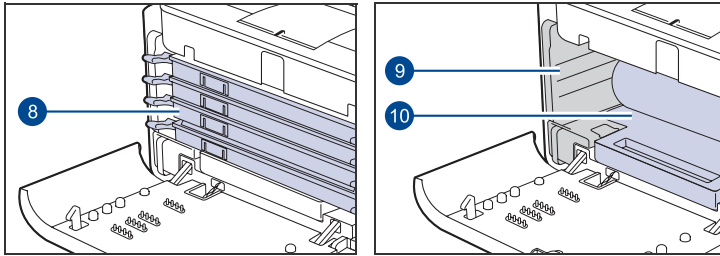
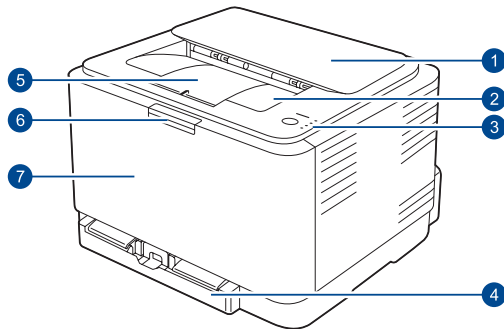

- | | |
|----|----------------------------|
| 1 | Top cover |
| 2 | Output tray (face down) |
| 3 | Control panel |
| 4 | Tray |
| 5 | Output support |
| 6 | Front cover release button |
| 7 | Front cover |
| 8 | Toner cartridge |
| 9 | Waste toner container |
| 10 | Imaging unit |

Rear view

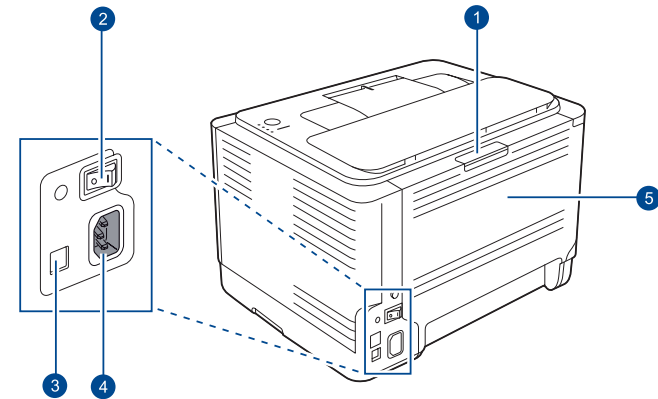

- | | |
|---|---------------------------|
| 1 | Rear cover release button |
| 2 | Power switch |
| 3 | USB port |
| 4 | Power receptacle |
| 5 | Rear cover |

CONTROL PANEL OVERVIEW

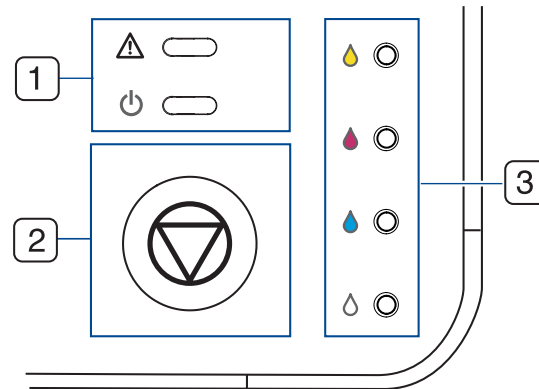

1 status LED	Shows the status of your printer. (See "Understanding the control panel" on page 12.)
2 stop button	Stops an operation at any time and also performs other functions. (See "Understanding the control panel" on page 12.)
3 toner colors LED	Show the status of each toner cartridge. (See "Understanding the control panel" on page 12.)

UNDERSTANDING THE CONTROL PANEL

The color of the status and toner colors LED indicates the printer's current status.

LEDs

STATUS	TONER COLORS LED	DESCRIPTION
lights green	all LEDs off	The printer is ready to print.
slowly blinks green	all LEDs off	The printer is receiving data from the computer.
fast blinks green	all LEDs off	The printer is printing data.
lights red	all LEDs off	<ul style="list-style-type: none">The printer is experiencing an error, such as open cover, empty paper, not installed waste toner container, or full waste toner container.The printer is experiencing a service required error, such as LSU error, fuser error, or ITB error, Contact your sales or service representative.
lights orange	all LEDs off	<ul style="list-style-type: none">The printer is experiencing an error such as jammed paper.While the printer is booting up, do not open a top cover, since the printer may treat it as an error such as paper jam. In this case, open a front cover and close it then, the printer will reboot up.
lights green	each LED blinks red	Each toner cartridge is near the end of its life.
blinks red	each LED lights red	Each toner cartridge is almost empty. You can print, but the quality is not reliable.
lights red	each LED lights red	<ul style="list-style-type: none">Each toner cartridge is totally exhausted. You cannot print anymore.Each toner cartridge is wrong.
lights green	each LED blinks red in a repeated order	The printer is warming up.

Stop button

	DESCRIPTION
Printing demo page	In Ready mode, press and hold this button for about 2 seconds until the status LED blinks slowly, and release.
Printing configuration sheets	In Ready mode, press and hold this button for about 5 seconds until the status LED blinks fast, and release.
Canceling print job	Press this button during printing. The red LED blinks while the print job is cleared from both the printer and the computer, and then the printer returns to Ready mode. This may take some time depending on the size of the print job.

SUPPLIED SOFTWARE

You must install the printer software using the supplied CD after you have set up your printer and connected it to your computer. The CD provides you with the following software.

CD	CONTENTS	
Printer software CD	Windows	<ul style="list-style-type: none"> • Printer driver: Use this driver to take full advantage of your printer's features. • Printer Setting Utility: This program allows you to set up printer's other options from your computer desktop. • Dell Toner Management System™: Displays the status of the printer and the name of the job when you send a job to print. The Dell Toner Management System™ window also displays the level of toner remaining and allows you to order replacement toner cartridges. • Status Monitor: This program allows you to monitor the printer's status and alerts you when an error occurs during printing.
	Macintosh	<ul style="list-style-type: none"> • Printer driver: Use this driver to run your printer from a Macintosh computer and print documents. • Printer Setting Utility: This program allows you to set up printer's other options from your computer desktop.

PRINTER DRIVER FEATURES

Your printer drivers support the following standard features:

- Paper orientation, size, source and media type selection
- Number of copies

In addition, you can use various special printing features. The following table shows a general overview of features supported by your printer drivers:

 Some models or operating system may not support the certain feature(s) in the following table.

Printer driver

FEATURE	WINDOWS	MACINTOSH
Color mode	O	O
printer quality option	O	O
Poster printing	O	X
Multiple pages per sheet (N-up)	O	O
Fit to page printing	O	O
Scale printing	O	O
Watermark	O	X
Overlay	O	X
Duplex (Manual)	O	X

getting started

This chapter gives you step-by-step instructions for setting up the printer.

This chapter includes:

- Setting up the hardware
- Printing a demo page
- System requirements

SETTING UP THE HARDWARE

This section shows the steps to set up the hardware which is explained in the *Quick Install Guide*. Ensure that you read *Quick Install Guide* and complete following steps.

1. Select a stable location.

Select a level, stable place with adequate space for air circulation. Allow extra space to open covers and trays.

The area should be well-ventilated and away from direct sunlight or sources of heat, cold, and humidity. Do not set the printer close to the edge of your desk or table.

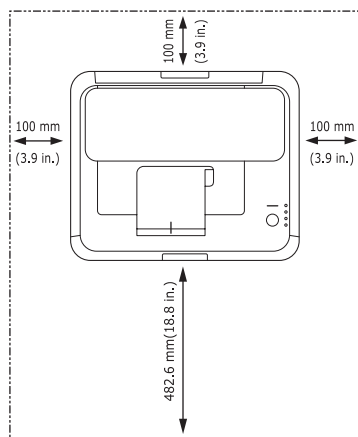

Printing is suitable for altitudes under 1,000 m (3,281 ft). Refer to the altitude setting to optimize your printing. See "Altitude adjustment" on page 16 for more information.

Place the printer on a flat and stable surface, not letting it lean more than 2 mm (0.08 inches). Otherwise, it may affect the printing quality.

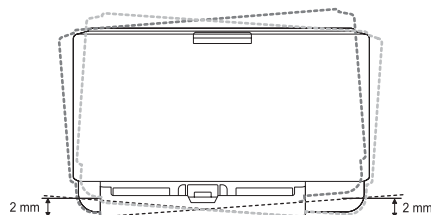

2. Unpack the printer and check all the enclosed items.
3. Remove the tape holding the printer tightly.
4. Load paper. (See "Changing the size of the paper in the paper tray" on page 20.)

- Installing the software
- printer's basic settings

5. Ensure that all the cables are connected to the printer.
6. Turn the printer on.

 When you move the printer, do not tilt or turn it upside down. Otherwise, the inside of the printer may be contaminated by toner, which can cause damage to the printer or produce bad print quality.

PRINTING A DEMO PAGE

Print a demo page to ensure that the printer is operating correctly. To print a demo page:

In Ready mode, press and hold the  **Stop** button for about 2 seconds.

SYSTEM REQUIREMENTS

Before you begin, ensure that your system meets the following requirements:

Microsoft® Windows®

Your printer supports the following Windows operating systems.

OPERATING SYSTEM	REQUIREMENT (RECOMMENDED)		
	CPU	RAM	FREE HDD SPACE
Windows 2000	Intel® Pentium® II 400 MHz (Intel Pentium III 933 MHz)	128 MB (256 MB)	600 MB
Windows XP	Intel Pentium III 933 MHz (Intel Pentium IV 1 GHz)	128 MB (256 MB)	1.5 GB
Windows 2003 Server	Intel Pentium III 933 MHz (Intel Pentium IV 1 GHz)	128 MB (512 MB)	1.25 GB to 2 GB
Windows Vista®	Intel Pentium IV 3 GHz	512 MB (1024 MB)	15 GB
Windows Server 2008	Pentium IV 1 GHz (Pentium IV 2 GHz)	512 MB (2048 MB)	10 GB

-  Internet Explorer 6.0 or higher is the minimum requirement for all Windows operating systems.
- Users who have an administrator rights can install the software.
- **Windows Terminal Services** is compatible with this machine.

Macintosh

OPERATING SYSTEM	REQUIREMENT (RECOMMENDED)		
	CPU	RAM	FREE HDD SPACE
Mac OS X 10.3 ~ 10.4	<ul style="list-style-type: none"> Intel Processor Power PC G4/G5 	<ul style="list-style-type: none"> 128 MB for a Power-PC based Mac (512 MB). 512 MB for an Intel-based Mac (1 GB) 	1 GB
Mac OS X 10.5	<ul style="list-style-type: none"> Intel Processor 867 MHz or faster Power PC G4/G5 	512 MB (1 GB)	1 GB

INSTALLING THE SOFTWARE

You have to install the printer software for printing. The software includes drivers, applications, and other user friendly programs.

The following procedure is based on Windows XP. If you use Macintosh operating system, see the *Software section*.

- The following procedure is based on the Windows XP operating system. The procedure and popup window which appear during the installation may differ depending on the operating system, the printer feature, or the interface in use.

1. Ensure that the printer is connected to your computer and powered on.

2. Insert the supplied CD into your CD drive.

The CD should automatically run, and an installation window appears. If the installation window does not appear, click **Start** then click **Run**. Type **X:\Setup.exe**, replacing "X" with the letter which represents your CD drive and click **OK**.

If you use Windows Vista, click **Start** → **All programs** → **Accessories** → **Run**, and type **X:\Setup.exe**.

If the **AutoPlay** window appears in Windows Vista, click **Run Setup.exe** in **Install or run program** field, and click **Continue** in the **User Account Control** window.

3. Click **Next**.

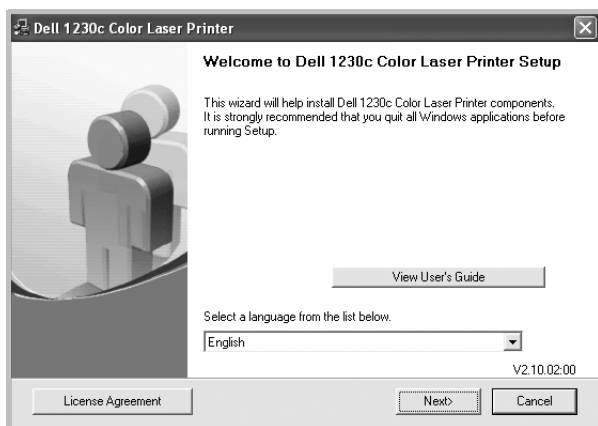

- If necessary, select a language from the drop-down list.
- **View User's Guide**: Allows you to view the User's Guide. If your computer doesn't have Adobe Acrobat, click on this option and it will automatically install Adobe Acrobat Reader for you.

4. Select **Typical**. Click **Next**.



- If your printer is not already connected to the computer, the following window will appear.

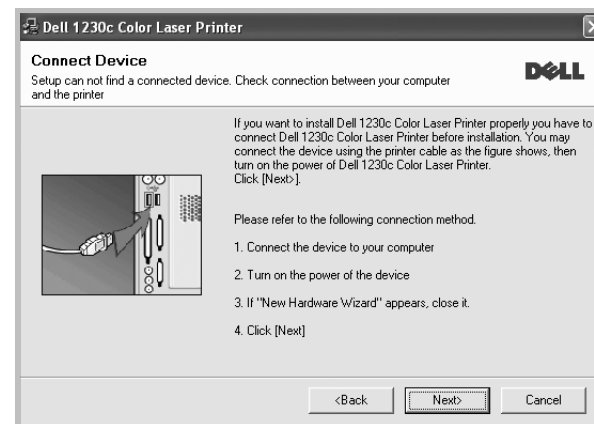

- After connecting the printer, click **Next**.
- If you don't want to connect the printer at this time, click **Next**, and **No** on the following screen. Then the installation will start and a test page will not be printed at the end of the installation.

5. After the installation is finished, a window asking you to print a test page appears. If you choose to print a test page, select the checkbox and click **Next**.

Otherwise, just click **Next** and skip to step 7.

6. If the test page prints out correctly, click **Yes**.

If not, click **No** to reprint it.

7. Click **Finish**.

- After setup is complete, if your printer driver does not work properly, reinstall the printer driver. See the *Software section* for more information.

PRINTER'S BASIC SETTINGS

After installation is complete, you may want to set the printer's default settings. Refer to the next section if you would like to set or change values.

Altitude adjustment

The print quality is affected by atmospheric pressure, which is determined by the height of the printer above sea level. The following information will guide you on how to set your printer to the best print quality or best quality of print.

Before you set the altitude value, find the altitude where you are using the printer.

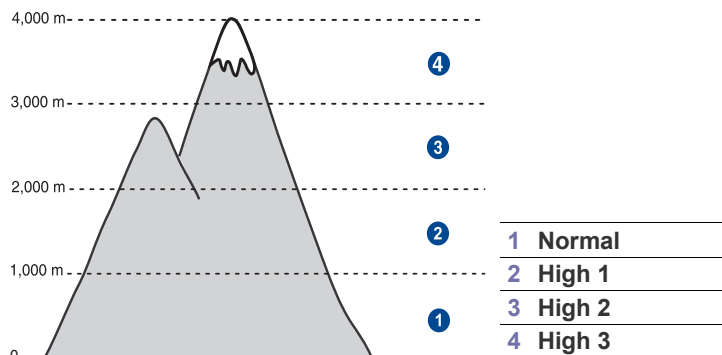

1. Click **Start** → **All programs** → **Dell** → **Dell Printer** → **Dell 1230c Color Laser Printer** → **Printer Setting Utility**.
You can also click **Printer Setting Utility** on the status bar in Mac OS X.
2. Click **Setting** > **Altitude Adjustment**. Select the appropriate value from the dropdown list, and then click **Apply**.

Using the save modes

Power Save mode

Power Save mode allows your printer to reduce power consumption when it is not in actual use. You can turn this mode on and select a length of time for which the printer waits after a job is printed before it switches to a reduced power state.

1. Click **Start** → **All programs** → **Dell** → **Dell Printer** → **Dell 1230c Color Laser Printer** → **Printer Setting Utility**.
You can also click **Printer Setting Utility** on the status bar in Mac OS X.
2. Click **Setting** > **Power Save**. Select the appropriate value from the dropdown list, and then click **Apply**.

Auto continue

This is the option to set the printer to continue printing or not, in case the paper size you have set and the paper within the tray mismatches.

1. Click **Start** → **All programs** → **Dell** → **Dell Printer** → **Dell 1230c Color Laser Printer** → **Printer Setting Utility**.
You can also click **Printer Setting Utility** on the status bar in Mac OS X.
2. Click **Setting** > **Auto Continue**. Select the appropriate value from the dropdown list, and then click **Apply**.

selecting and loading print media

This chapter introduces you how to load originals and print media into your printer.

This chapter includes:

- Selecting print media
- Changing the size of the paper in the paper tray
- Printing on special print materials
- Adjusting the output support
- Setting the paper size and type

SELECTING PRINT MEDIA

You can print on a variety of print media, such as plain paper, envelopes, labels, and transparencies. Always use print media that meet the guidelines for use with your printer. Print media that does not meet the guidelines outlined in this user's guide may cause the following problems:

- Poor print quality
- Increased paper jams
- Premature wear on the printer.

Properties, such as weight, composition, grain, and moisture content, are important factors that affect the printer's performance and the output quality. When you choose print materials, consider the following:

- The type, size and weight of the print media for your printer are described later in this section.
- Desired outcome: The print media you choose should be appropriate for your project.
- Brightness: Some print media are whiter than others and produce sharper, more vibrant images.
- Surface smoothness: The smoothness of the print media affects how crisp the printing looks on the paper.

-  • Some print media may meet all of the guidelines in this section and still not produce satisfactory results. This may be the result of improper handling, unacceptable temperature and humidity levels, or other variables over which Dell has no control.
 - Before purchasing large quantities of print media, ensure that it meets the requirements specified in this user's guide.

 Using print media that does not meet these specifications may cause problems, requiring repairs. Such repairs are not covered by Dell's warranty or service agreements.

 Ensure that you do not use the inkjet photo paper with this printer. It could cause damage to the printer.

Specifications on print media

TYPE	SIZE	DIMENSIONS	WEIGHT ^A	CAPACITY ^B
Plain paper	Letter	216 x 279 mm (8.5 x 11 inches)	• 60 to 105 g/m ² (16 to 28 lb bond)	<ul style="list-style-type: none"> • 150 sheets of 75 g/m² (20 lb bond) paper for the tray • 1 sheet for manual feeding in the tray
	Legal	216 x 356 mm (8.5 x 14 inches)		
	Folio	216 x 330 mm (8.5 x 13 inches)	• 60 to 163 g/m ² (16 to 43 lb bond)	
	A4	210 x 297 mm (8.26 x 11.69 inches)		
	Oficio	216 x 343 mm (8.5 x 13.5 inches)		
	JIS B5	182 x 257 mm (7.16 x 10.11 inches)		
	ISO B5	176 x 250 mm (6.93 x 9.84 inches)		
	Executive	184 x 267 mm (7.25 x 10.5 inches)		
	Statement	140 x 216 mm (5.50 x 8.50 inches)		
	A5	148 x 210 mm (5.82 x 8.26 inches)		
	A6	105 x 148 mm (4.13 x 5.82 inches)		
Envelope	Monarch	98 x 191 mm (3.87 x 7.5 inches)	75 to 90 g/m ² (20 to 24 lb bond)	5 sheets for manual feeding in the tray
	No. 10	105 x 241 mm (4.12 x 9.5 inches)		
	DL	110 x 220 mm (4.33 x 8.66 inches)		
	C5	162 x 229 mm (6.37 x 9.01 inches)		
	C6	114 x 162 mm (4.48 x 6.38 inches)		
	No.9	98 x 225 mm (3.87 x 8.87 inches)		
	6 3/4	92 x 165 mm (3.62 x 6.5 inches)		
Thick paper	Refer to the Plain paper section	Refer to the Plain paper section	90 to 105 g/m ² (24 to 28 lb bond)	
Thin paper	Refer to the Plain paper section	Refer to the Plain paper section	60 to 70 g/m ² (16 to 19 lb bond)	
Labels ^c	Letter, A4	Refer to the Plain paper section	120 to 150 g/m ² (32 to 40 lb bond)	
Card stock	Post card	101.6 x 152.4 mm (4 x 6 inches)	105 to 163 g/m ² (28 to 43 lb bond)	
Transparency ^d	Letter, A4	Refer to the Plain paper section	138 to 146 g/m ² (37 to 39 lb bond)	1 sheet for manual feeding in the tray
Glossy paper	Letter, A4	Refer to the Plain paper section	160 g/m ² (44 lb bond)	
Minimum size (custom)		76 x 160 mm (3 x 6.3 inches)	60 to 163 g/m ² (16 to 43 lb bond)	
Maximum size (custom)		216 x 356 mm (8.5 x 14 inches)		

a. If media weight is over 105 g/m² (28 lb bond), load a paper into the tray one by one.

b. Maximum capacity may differ depending on media weight, thickness, and environmental conditions.

c. Smoothness: 100 to 250 (sheffield)

d. Recommended media: Transparency for a color laser printer by Xerox such as 3R 91331(A4), 3R 2780(Letter).

Guidelines for special print media

MEDIA TYPE	GUIDELINES
Envelopes	<ul style="list-style-type: none"> Successful printing on envelopes depends upon the quality of the envelopes. When selecting envelopes, consider the following factors: <ul style="list-style-type: none"> Weight: The weight of the envelope paper should not exceed 90 g/m² or jamming may occur. Construction: Prior to printing, envelopes should lie flat with less than 6 mm curl, and should not contain air. Condition: Envelopes should not be wrinkled, nicked, or otherwise damaged. Temperature: You should use envelopes that are compatible with the heat and pressure of the printer during operation. Use only well-constructed envelopes with sharp and well creased folds. Do not use stamped envelopes. Do not use envelopes with clasps, snaps, windows, coated lining, self-adhesive seals, or other synthetic materials. Do not use damaged or poorly made envelopes. Be sure the seam at both ends of the envelope extends all the way to the corner of the envelope. <div data-bbox="459 832 772 1083" style="text-align: center;"> <p>1 Acceptable 2 Unacceptable</p> </div> <ul style="list-style-type: none"> Envelopes with a peel-off adhesive strip or with more than one flap that folds over to seal must use adhesives compatible with the printer's fusing temperature for 0.1 second. Check your printer's specification to view the fusing temperature. See "General specifications" on page 39. The extra flaps and strips might cause wrinkling, creasing, or jams, and may even damage the fuser. For the best print quality, position margins no closer than 15 mm from the edges of the envelope. Avoid printing over the area where the envelope's seams meet.

MEDIA TYPE	GUIDELINES
Labels	<ul style="list-style-type: none"> To avoid damaging the printer, use only labels designed for use in laser printers. <ul style="list-style-type: none"> When selecting labels, consider the following factors: <ul style="list-style-type: none"> Adhesives: The adhesive material should be stable at your printer's fusing temperature. Check your printer's specification to know the fusing temperature. See "General specifications" on page 39. Arrangement: Only use labels with no exposed backing between them. Labels can peel off sheets that have spaces between the labels, causing serious jams. Curl: Prior to printing, labels must lie flat with no more than 13 mm of curl in any direction. Condition: Do not use labels with wrinkles, bubbles, or other indications of separation. Ensure that there is no exposed adhesive material between labels. Exposed areas can cause labels to peel off during printing, which can cause paper jams. Exposed adhesive can also cause damage to printer components. Do not run a sheet of labels through the printer more than once. The adhesive backing is designed for only a single pass through the printer. Do not use labels that are separating from the backing sheet or are wrinkled, bubbled, or otherwise damaged.
Card stock or custom-sized materials	<ul style="list-style-type: none"> Do not print on media smaller than 76 mm wide or 356 mm long. In the software application, set margins at least 6.4 mm away from the edges of the material.
Preprinted paper	<ul style="list-style-type: none"> Letterhead must be printed with heat-resistant ink that will not melt, vaporize, or release hazardous emissions when subjected to the printer's fusing temperature for 0.1 second. Check your printer's specification to know the fusing temperature. See "General specifications" on page 39. Letterhead ink must be non-flammable and should not adversely affect printer rollers. Forms and letterhead should be sealed in a moisture-proof wrapping to prevent changes during storage. Before you load preprinted paper, such as forms and letterhead, verify that the ink on the paper is dry. During the fusing process, wet ink can come off preprinted paper, reducing print quality.

 Using photographic paper or coated paper may cause problems, requiring repairs. Such repairs are not covered by Dell's warranty or service agreements.

CHANGING THE SIZE OF THE PAPER IN THE PAPER TRAY

To load different sizes of paper, such as Legal-sized paper, you need to adjust the paper guides to extend the paper tray. To change the tray size to other size, you must adjust the paper length guide properly.

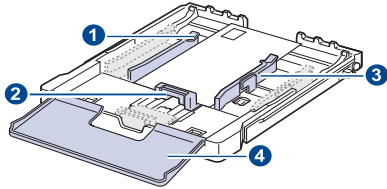

- 1 Tray extend lever
- 2 Paper length guide
- 3 Paper width guide
- 4 Paper cover

1. Pull the tray out of the printer. Open the paper cover and remove paper from the tray if necessary.

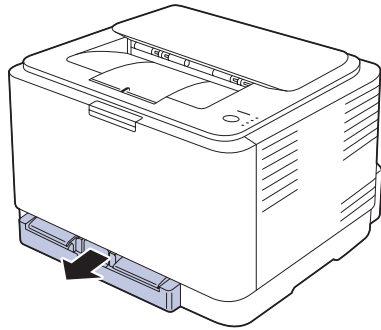

2. Pressing and unlatching the guide lock in the top of the tray, pull the tray out manually.

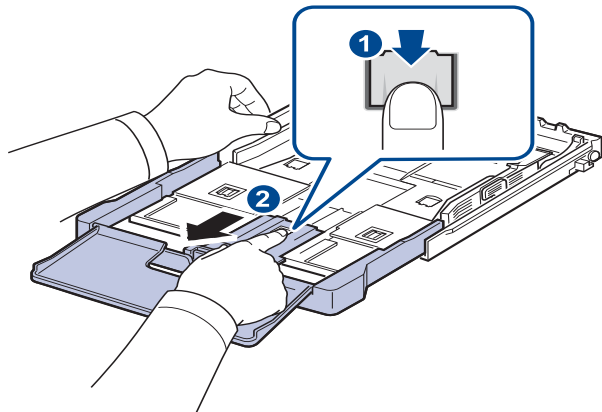

3. Load paper into the tray.

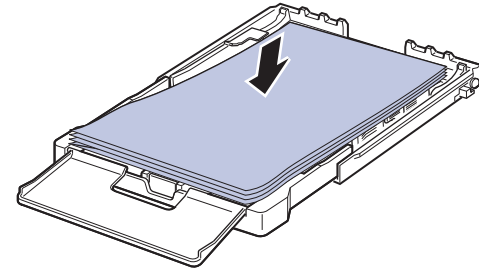

4. Slide the paper length guide until it lightly touches the end of the paper stack. Squeeze the paper width guide and slide it to the edge of the paper stack without causing it to bend.

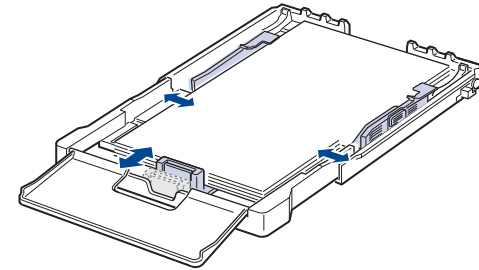

For paper smaller than Letter-sized, return the paper guides to their original positions and adjust the paper length guide and paper width guide.

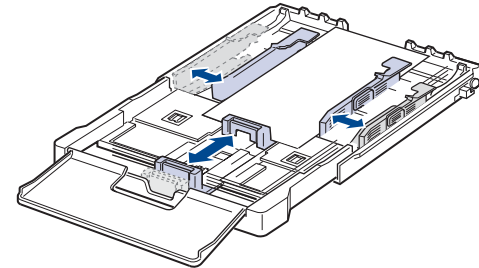

If the paper that you need to print is shorter than length 222 mm (8.74 inches), press and unlatch the guide lock in the tray, push the tray in

manually. Adjust the paper length guide and paper width guide.

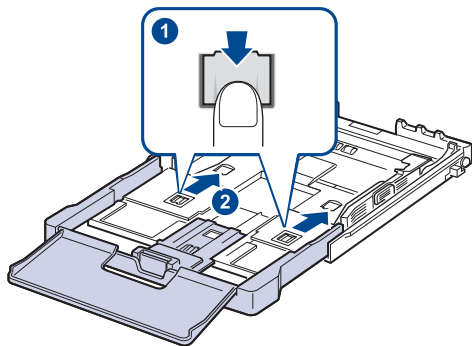

- Do not push the paper width guides far enough to cause the materials to warp.
- If you do not adjust the paper width guides, it may cause paper jams.

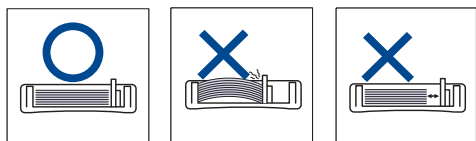

5. Close the paper cover.

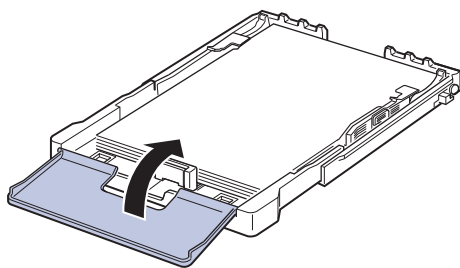

6. Slide the tray back into the printer until it clicks.
7. After loading paper, set the paper type and size for the tray. See "Setting the paper size and type" on page 22.

- If you experience problems with paper feed, place one sheet at a time in the tray.
- You can load previously printed paper. The printed side should be facing up with an uncurled edge at the rear. If you experience problems with paper feed, turn the paper around. Note that print quality is not guaranteed.

The tray is preset to Letter or A4 size, depending on your country. To change the size to A4 or Letter, you must adjust the lever and paper width guide properly.

- Pull the tray out of the printer. Open the paper cover and remove paper from the tray if necessary.
- If you want to change the size to Letter, hold the lever at the back of the tray, and rotate the lever clockwise.

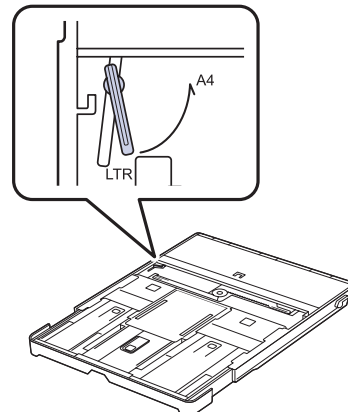

3. Squeeze the paper width guide and slide it to the edge of the lever.

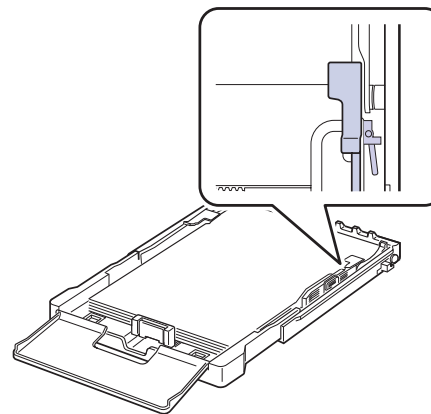

- If you want to change the size to A4, first move the paper width guide to left and rotate the lever counterclockwise. If you force the lever, it could damage the tray.

PRINTING ON SPECIAL PRINT MATERIALS

The printer can hold special sizes and types of print material, such as postcards, note cards, and envelopes. Especially, it is useful for single page printing on letterhead or colored paper.

Feeding the print material manually

- Load only one size of print media at a time in the tray.
- To prevent paper jams, do not add paper when there is still paper in the tray. This also applies to other types of print media.
- Print media should be loaded face up with the side you want to print, and the top edge going into the tray first. Place print materials in the center of the tray.
- Always load only the specified print media to avoid paper jams and print quality problems. (See "Selecting print media" on page 17.)
- Flatten any curl on postcards, envelopes, and labels before loading them into the tray.



1. Load the paper. (See "Changing the size of the paper in the paper tray" on page 20.)

-  Depending on the media type you are using, keep the following loading guidelines:
- Envelopes: Flap side down and with the stamp area on the top left side.
 - Labels: Print side up and top short edge entering the printer first.
 - Preprinted paper: Design side up with the top edge toward the printer.
 - Card stock: Print side up and the short edge entering the printer first.
 - Previously printed paper: Previously printed side down with an uncurled edge toward the printer.

2. When you print in application, start the print menu.
3. Before you print, open printer properties.
4. Press the **Paper** tab in printer properties, and select an appropriate paper type.

-  If you want to use an label, set the paper type to **Label**.

5. Select **Manual Feeder** in paper source then, press **OK**.
6. Start printing in application.
7. Press the  **Stop** button on the printer to start feeding then the printer starts printing.

-  • If you are printing multiple pages, load the next sheet after first page prints out, and press the  **Stop** button. Repeat this step for every page to be printed.
- The settings you change remain in effect only while you are using the current application.

ADJUSTING THE OUTPUT SUPPORT

The printed pages stack on the output tray, and the output support will help the printed pages align. To let the output support correctly align the pages you need to pull it out appropriately depending on the paper size.

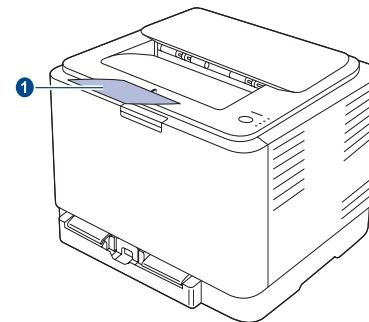

1 Output support

-  • If the output support is incorrectly adjusted, printed pages may be mis-aligned or fall.
- If you continuously print many pages, the surface of the output tray may become hot. Be careful not to touch the surface, and especially keep children away from the surface.

SETTING THE PAPER SIZE AND TYPE

After loading paper in the paper tray, you need to set the paper size and type using the printer driver. Follow these steps to make your changes permanent.

-  The following procedure is for Windows XP. For other Windows operating system, refer to the corresponding Windows User's Guide or online help.

1. Click the **Start** button on the computer screen.
2. Select **Printers and Faxes**.
3. Right-click on the printer driver icon and select **Printing Preferences**.
4. Click the **Paper** tab, and change the settings on **Paper Options**.
5. Click **OK**.

basic printing

This chapter explains common printing tasks.

This chapter includes:

- Printing a document
- Canceling a print job

PRINTING A DOCUMENT

Your printer allows you to print from various Windows, or Macintosh applications. The exact steps for printing a document may vary depending on the application you use.

For details about printing, see the Software section.

CANCELING A PRINT JOB

If the print job is waiting in a print queue or print spooler, such as the printer group in Windows, delete the job as follows:

1. Click the Windows **Start** menu.
2. For Windows 2000, select **Settings** and then **Printers**.
For Windows XP/2003, select **Printers and Faxes**.
For Windows Vista, select **Control Panel > Hardware and Sound > Printers**.
3. Double-click the Dell 1230c icon.
4. From the **Document** menu, select **Cancel**.

 You can also access this window by simply double-clicking the printer icon at the bottom right corner of the Windows desktop.

You can also cancel the current job by pressing  **Stop** on the control panel.

maintenance

This chapter provides information for maintaining your printer and the toner cartridge.

This chapter includes:

- Printing reports
- Cleaning your printer
- Maintaining the cartridge
- Replacing the toner cartridge

PRINTING REPORTS

You can print a configuration report from the printer's control panel. Use the configuration page to view the current settings, to help troubleshoot problems. In Ready mode, press and hold the  **Stop** button on the control panel for about 5 seconds.

CLEANING YOUR PRINTER

To maintain print quality, follow the cleaning procedures below each time the toner cartridge is replaced or if print quality problems occur.

- ⚠ • Cleaning the cabinet of the printer with cleaning materials containing large amounts of alcohol, solvent, or other strong substances can discolor or distort the cabinet.
- If your printer or its surrounding is contaminated with toner, we recommend you to use cloth or tissue dampened with water to clean it. If you use a vacuum cleaner, toner blown into the air may be harmful.

Cleaning the outside

Clean the cabinet of the printer with a soft lint-free cloth. You can dampen the cloth slightly with water, but be careful not to let any water drip onto or into the printer.

Cleaning the inside

During the printing process, paper, toner, and dust particles can accumulate inside the printer. This buildup can cause print quality problems, such as toner specks or smearing. Cleaning the inside of the printer clears or reduces these problems.

1. Turn the printer off and unplug the power cord. Wait for the printer to cool down.
2. Press the release button, completely open the front cover.

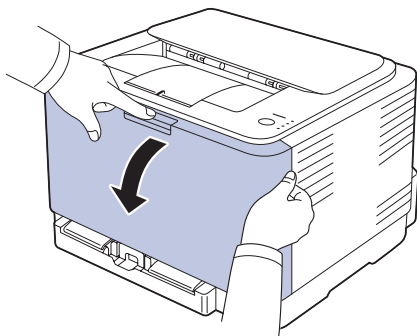

- Replacing the Imaging Unit
- Replacing the waste toner container
- Maintenance parts

3. Grasp the handles on the toner cartridge and pull to remove the cartridge from the printer.

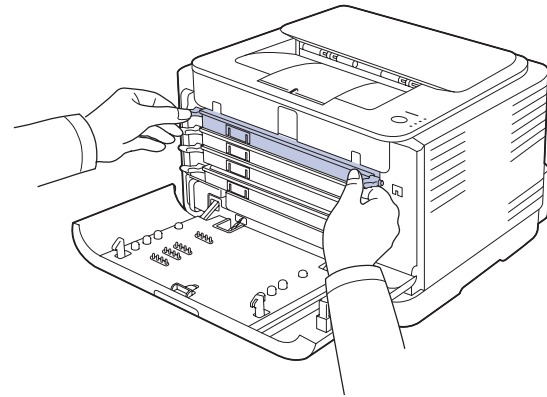

4. Pull the waste toner container out of the printer using its handle.

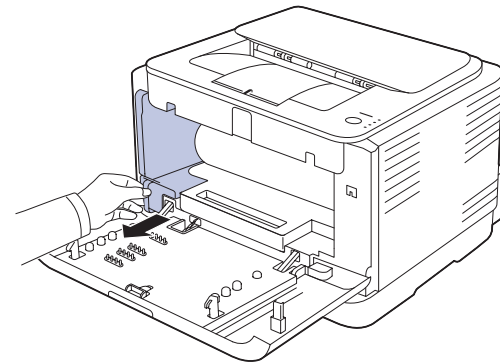

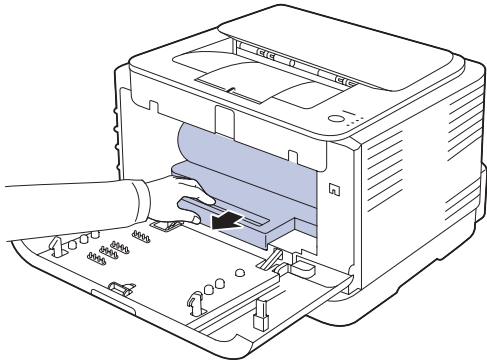

5. Pull the imaging unit out of the printer using the groove on the front of the imaging unit.

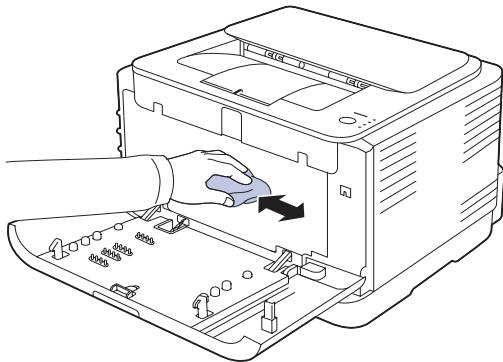

-  • Do not touch the green surface on the imaging unit with your hands or any other material.
- Be careful not to scratch the surface of the imaging unit.
 - If you leave the front cover open for more than a few minutes, the imaging unit can be exposed to light. This will cause damage to the imaging unit. Close the front cover should the installation need to be halted for any reason.

6. With a dry lint-free cloth, wipe away any dust and spilled toner from the toner cartridges area and their cavities.



-  • If toner gets on your clothing, wipe it off with a dry cloth and wash it in cold water. Hot water sets toner into fabric.
- If your printer or its surrounding is contaminated with toner, we recommend you to use a cloth or tissue dampened with water to clean it. If you use a vacuum cleaner, toner blows into the air then might be harmful to you.

-  After cleaning, let the printer to dry completely.

7. Holding the groove on the front of the imaging unit, push imaging unit in to the printer.

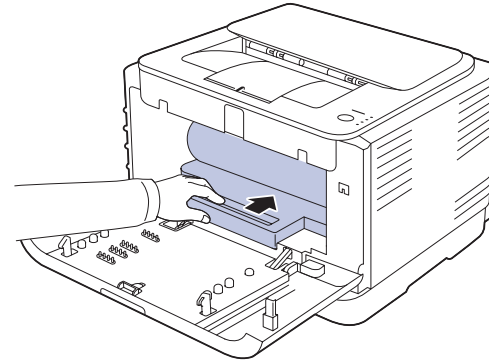

8. Insert the waste toner container into position and then push it to ensure that it is firmly seated in place.

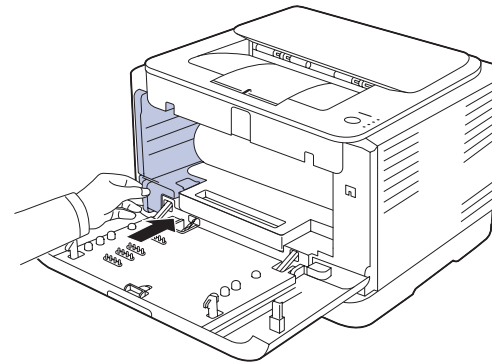

9. Slide the toner cartridge back into the printer.

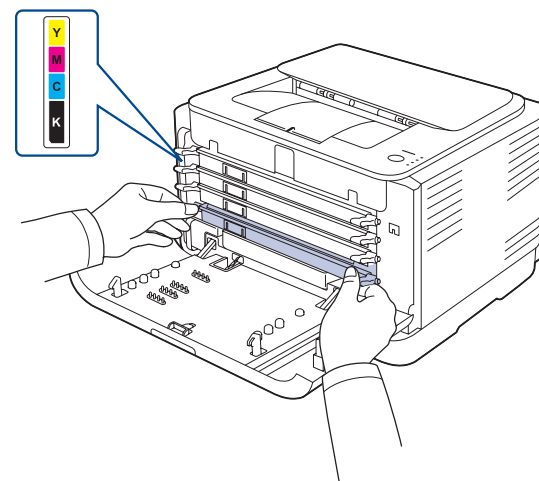

10. Reinstall all the compartments into the printer, and close the front cover.

-  If the front cover is not completely closed, the printer will not operate.

11. Plug in the power cord and turn the printer on

MAINTAINING THE CARTRIDGE

Toner cartridge storage

To get the most from the toner cartridge, keep the following guidelines in mind:

- Do not remove the toner cartridge from its package until ready for use.
- Do not refill the toner cartridge. The printer warranty does not cover damage caused by using a refilled cartridge.
- Store toner cartridges in the same environment as your printer.
- To prevent damage to the toner cartridge, do not expose it to light for more than a few minutes.

Expected cartridge life

The life of the toner cartridge yield depends on the amount of toner that print jobs require. The actual number may also be different depending on the print density of the pages you print on, and the number of pages may be affected by operating environment, printing interval, media type, and media size. If you print a lot of graphics, you may need to change the cartridge more often.

Redistributing toner

When a toner is low, faded or light areas may appear. It is possible that colored images may be printed with incorrect colors due to flawed mixing of toner colors when one of the colored toner cartridges is low on toner. You can temporarily improve print quality by redistributing the toner.

- The toner-related message saying that the toner is low may appear on the display.
- The SmartPanel program window appears on the computer telling you which color cartridge is low on toner.

1. Press the release button, completely open the front cover.

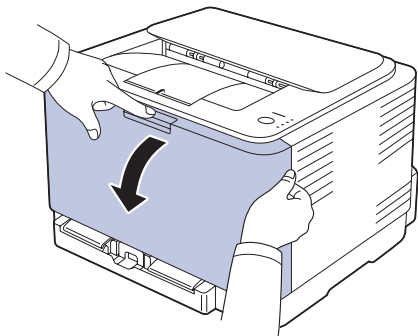

2. Grasp the handles on the toner cartridge and pull to remove the cartridge from the printer.

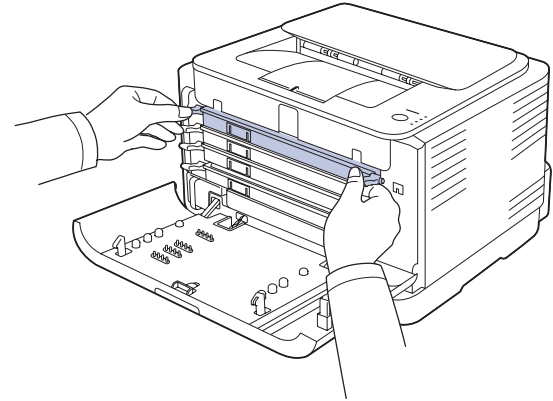

3. Holding both handles on the toner cartridge, thoroughly rock it from side to side to evenly distribute the toner.

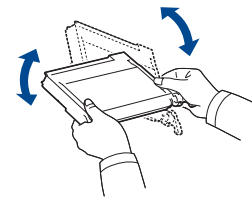

-  If toner gets on your clothing, wipe it off with a dry cloth and wash it in cold water. Hot water sets toner into fabric.

4. Slide the toner cartridge back into the printer.

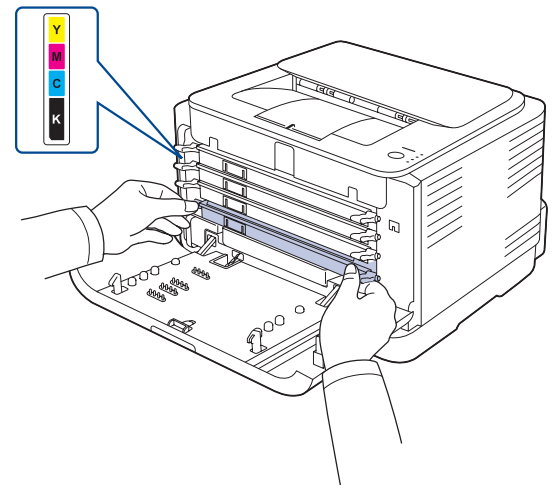

5. Close the front cover. Ensure that the cover is securely latched.

-  If the front cover is not completely closed, the printer will not operate.

REPLACING THE TONER CARTRIDGE

The printer uses four colors and has a different toner cartridge for each one: yellow (Y), magenta (M), cyan (C), and black (K).

When the toner colors LED, on the control panel, indicating each individual toner cartridge according to its color, lights red, and the status LED lights red, the printer cartridge is totally exhausted. Your printer stops printing.

Also, the **Dell Toner Management System™** program window appears on the computer telling you to replace the cartridge.

At this stage, the toner cartridge needs to be replaced. Check the type of toner cartridge for your printer. (See "Supplies" on page 38.)

1. Turn the printer off, then wait a few minutes for the printer to cool.
2. Press the release button, completely open the front cover.

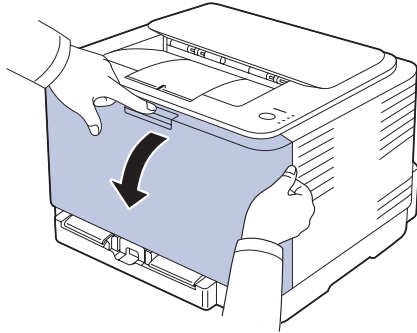

3. Grasp the handles on the toner cartridge and pull to remove the cartridge from the printer.

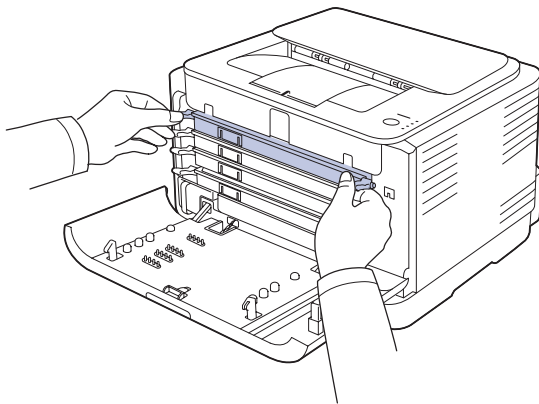

4. Take a new toner cartridge out of its package.



- Don't use sharp objects, such as a knife or scissors, to open the toner cartridge package. You could damage the surface of the toner cartridge.
- To prevent damage, do not expose the toner cartridge to light for more than a few minutes. Cover it with a piece of paper to protect it if necessary.

5. Holding both handles on the toner cartridge, thoroughly rock it from side to side to evenly distribute the toner.

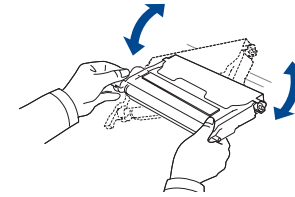

6. Place the toner cartridge on a flat surface, as shown, and remove the protecting cover.

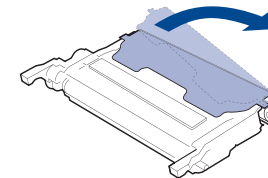

- If toner gets on your clothing, wipe it off with a dry cloth and wash it in cold water. Hot water sets toner into fabric.

7. Ensure that the color of the toner cartridge matches the color slot and then grasp the handles on the toner cartridge. Insert the cartridge until it clicks into place.

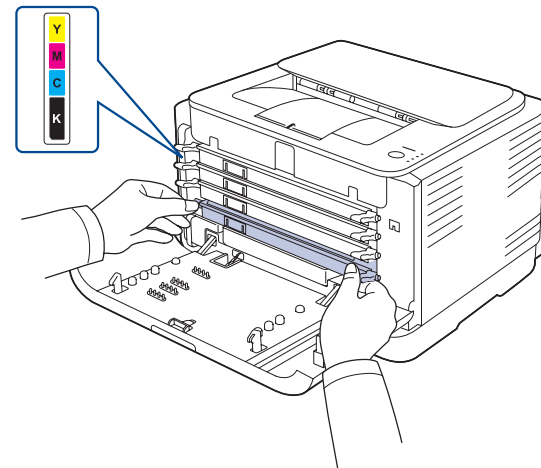

8. Close the front cover. Ensure that the cover is securely latched, and then turn the printer on.

- If the front cover is not completely closed, the printer will not operate.

REPLACING THE IMAGING UNIT

When the life span of the imaging unit has expired, the **Dell Toner Management System™** program window appears on the computer, indicating the imaging unit needs to be replaced. Otherwise your printer stops printing.

1. Turn the printer off, then wait a few minutes for the printer to cool.
2. Press the release button, completely open the front cover.

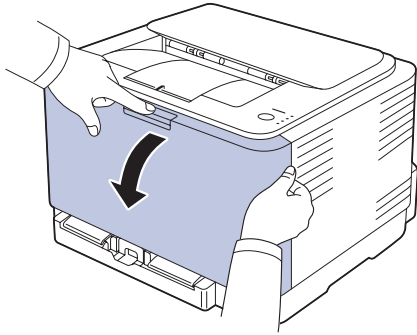

3. Grasp the handles on the toner cartridge and pull to remove the cartridge from the printer.

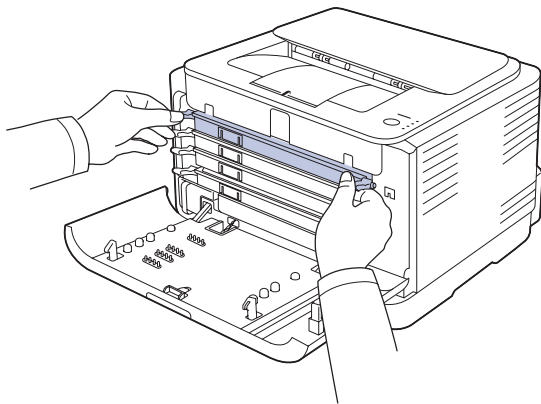

4. Pull the waste toner container out of the printer using its handle.

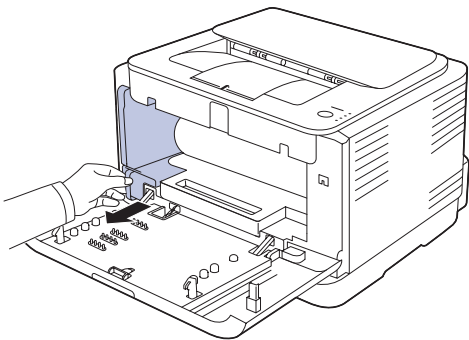

5. Pull the imaging unit out of the printer using the groove on the front of the imaging unit.

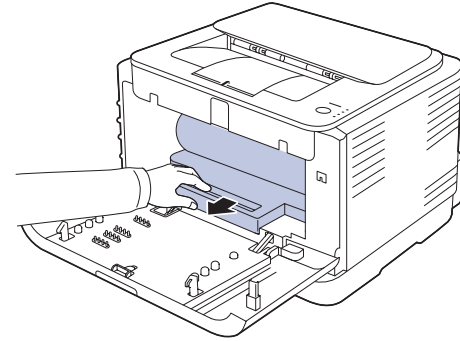

6. Take a new imaging unit out of its package.

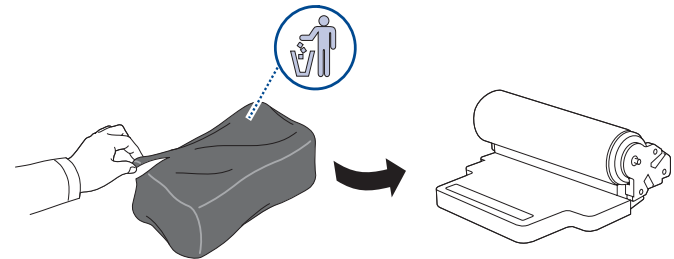

- Don't use sharp objects, such as a knife or scissors, to open the imaging unit package. You could damage the surface of the imaging unit.
- Be careful not to scratch the surface of the imaging unit.
- To prevent damage, do not expose the imaging unit to light for more than a few minutes. Cover it with a piece of paper to protect it if necessary.

7. Holding the groove on the front of the imaging unit, push imaging unit in to the printer.

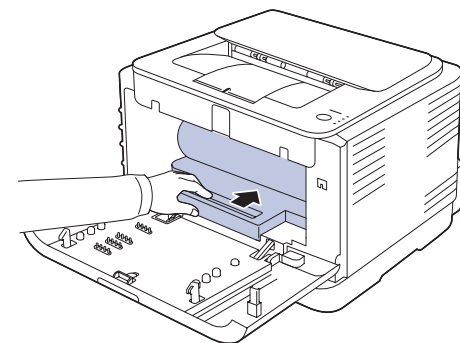

8. Insert the waste toner container into position and then push it to ensure that it is firmly seated in place.

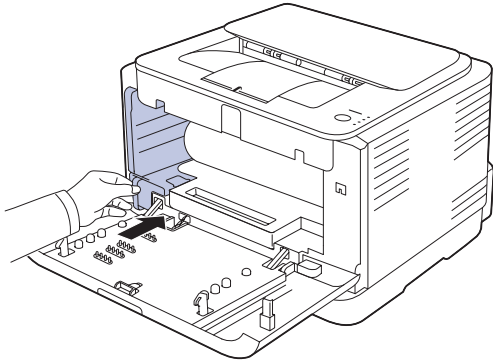

9. Slide the toner cartridge back into the printer.

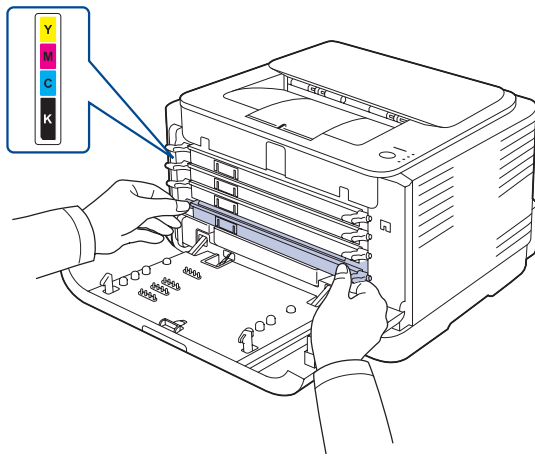

10. Close the front cover firmly.

 If the front cover is not completely closed, the printer will not operate. Ensure that all toner cartridges are installed properly. If any toner cartridge is installed improperly, the front cover do not close.

11. Turn the printer on.

 Each LED blinks red in a repeated order. Wait for about 1.5 minutes for your printer to get ready.

REPLACING THE WASTE TONER CONTAINER

When the life span of the waste toner container has expired, the **Dell Toner Management System™** program window appears on the computer, indicating the waste toner container needs to be replaced. Otherwise your printer stops printing.

1. Turn the printer off, then wait a few minutes for the printer to cool.
2. Open the front cover.

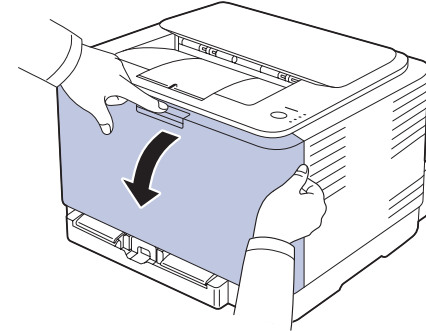

3. Pull the waste toner container out of the printer using its handle.

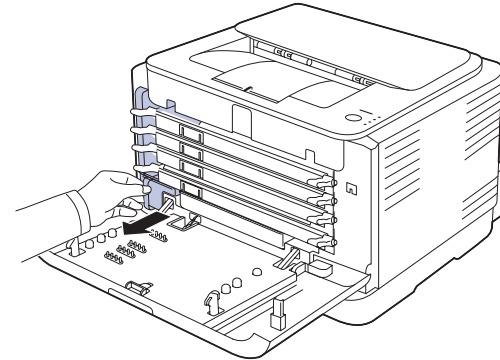

 Ensure that you lay the waste toner container on a flat surface so that the toner does not spill.

4. Remove the container's cap from the container as shown below, and use it to close the waste toner container opening.

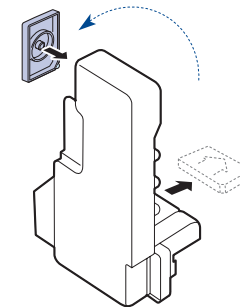

 Do not tilt or turn over the container.

5. Take a new waste toner container out of its package.

6. Insert the new container into position and then push it to ensure that it is firmly seated in place.

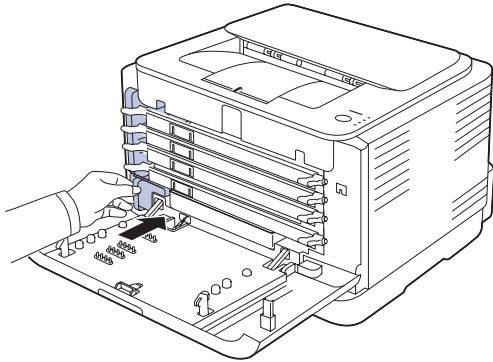

7. Close the front cover firmly.

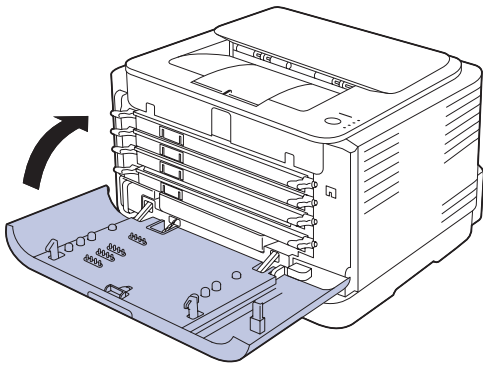

-  If the front cover is not completely closed, the printer will not operate. Ensure that all toner cartridges are installed properly. If any toner cartridge is installed improperly, the front cover do not close.

8. Turn the printer on.

MAINTENANCE PARTS

To avoid print quality and paper feed problems resulting from worn parts, and to maintain your printer in top working condition the following condition, the following items will need to be replaced after the specified number of pages, or when the life span of each item has expired.

ITEMS	YIELD (AVERAGE)
Pick-up roller	Approx. 50,000 pages
Fuser unit	Approx. 100,000 black pages or 25,000 color pages
Transfer roller	Approx. 100,000 pages
Transfer Unit (ITB)	Approx. 100,000 black pages or 25,000 color pages

It is highly recommend that this maintenance be performed by an authorized service provider, dealer or the retailer where you bought the printer. The warranty does not cover the replacement of the maintenance parts after their lifespan.

troubleshooting

This chapter gives helpful information for what to do if you encounter an error.

This chapter includes:

- Tips for avoiding paper jams
- Clearing paper jams

TIPS FOR AVOIDING PAPER JAMS

By selecting the correct media types, most paper jams can be avoided.

- See "Changing the size of the paper in the paper tray" on page 20. Ensure that the adjustable guides are positioned correctly.
- Do not overload the tray. Ensure that the paper level is below the paper capacity mark on the inside of the tray.
- Do not remove paper from the tray while your printer is printing.
- Flex, fan, and straighten paper before loading.
- Do not use creased, damp, or highly curled paper.
- Do not mix paper types in a tray.
- Use only recommended print media. (See "Setting the paper size and type" on page 22.)
- Ensure that the recommended side of the print media is facing up in the tray.

CLEARING PAPER JAMS

 To avoid tearing the paper, pull the jammed paper out gently and slowly. Follow the instructions in the following sections to clear the jam.

If a paper jam occurs, the status LED on the control panel lights red. Find and remove the jammed paper.

To resume printing after clearing paper jams, you must open and close the front cover or rear cover.

If paper is jammed in the paper feed area, follow the next steps to release the jammed paper.

1. Pull the tray out of the printer and remove the jammed paper.

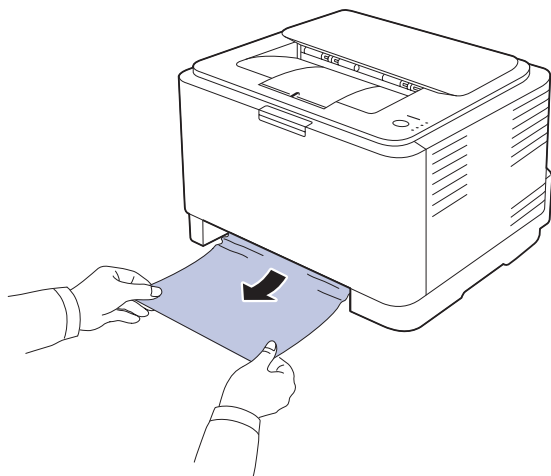

If you cannot find the jammed paper, go to the next step.

- Solving other problems

2. To remove the jammed paper, open the rear cover.

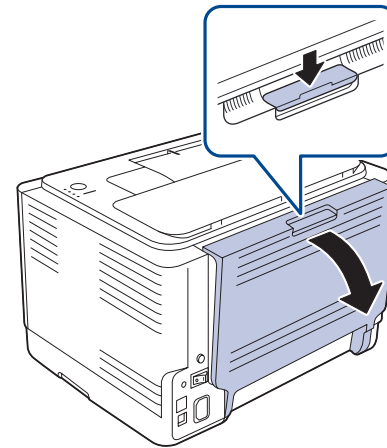

3. Carefully remove the paper by pulling in the direction as shown below. Most of the jammed paper can be removed in this step.

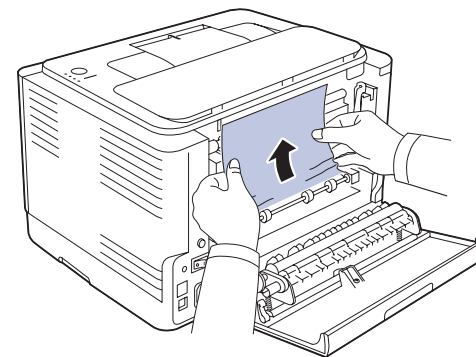

If you cannot find the jammed paper, or if there is any resistance removing the paper, stop pulling and go to the next step.

-  If the paper tears, ensure that all of the paper fragments are removed from the printer.

4. Push the fuser levers upwards.

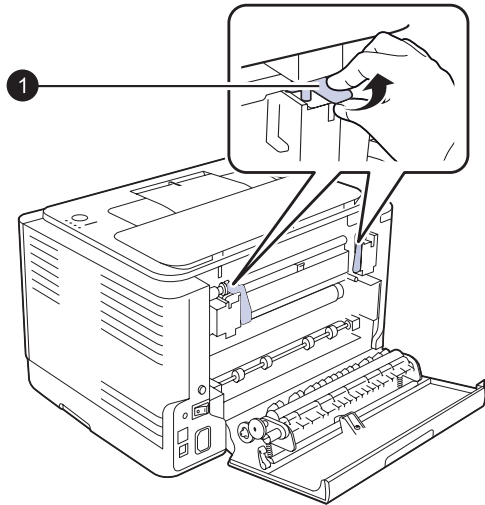

5. Open the top cover and inner cover.

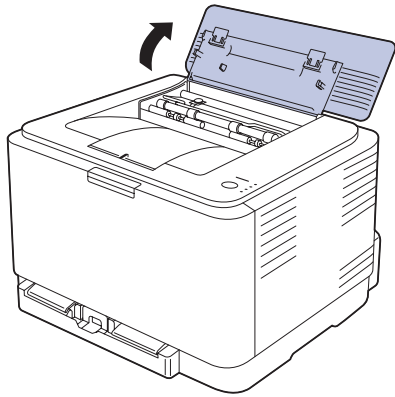

6. Holding the inner cover open, carefully take the jammed paper out of the printer. The inner cover will then close automatically.

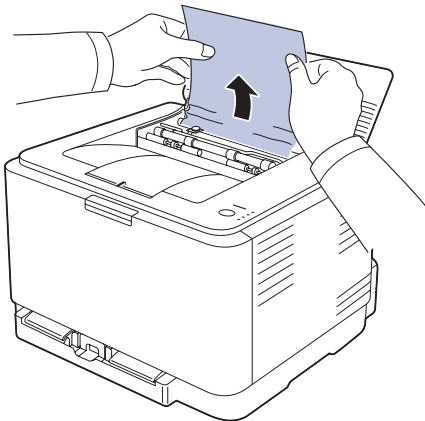

 Do not touch the fuser inside the inner cover. It is hot and could cause burns! The fuser's operating temperature is 180 °C (356 °F). Take care when removing paper from the printer.

7. Close the top cover. Ensure that it is securely closed.

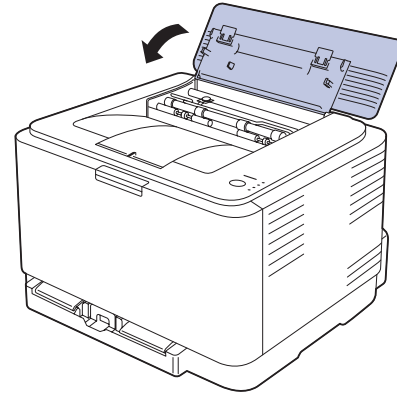

8. Push the fuser levers downwards.

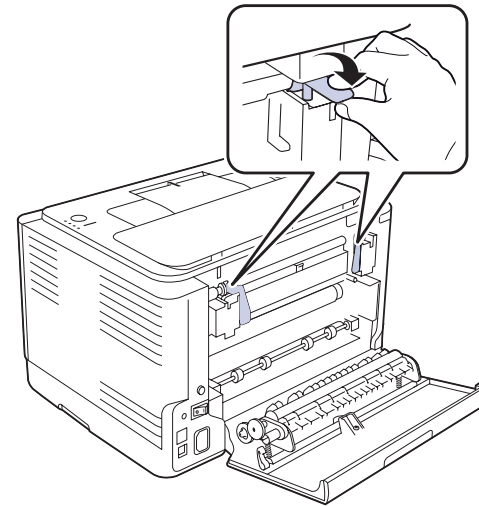

9. Open and then close the rear cover or front cover to resume printing.

SOLVING OTHER PROBLEMS

The following chart lists some conditions that may occur and the recommended solutions. Follow the suggested solutions until the problem is corrected. If the problem persists, call for service.

Paper feeding

CONDITION	SUGGESTED SOLUTIONS
Paper is jammed during printing.	Clear the paper jam. See "Tips for avoiding paper jams" on page 31.
Paper sticks together.	<ul style="list-style-type: none"> Ensure there is not too much paper in the tray. The tray can hold up to 150 sheets of paper, depending on the thickness of your paper. Ensure that you are using the correct type of paper. See "Setting the paper size and type" on page 22. Remove paper from the tray and flex or fan the paper. Humid conditions may cause some paper to stick together.
Multiple sheets of paper do not feed.	<ul style="list-style-type: none"> Different types of paper may be stacked in the tray. Load paper of only one type, size, and weight. If multiple sheets have caused a paper jam, clear the paper jam. See "Tips for avoiding paper jams" on page 31.
Paper does not feed into the printer.	<ul style="list-style-type: none"> Remove any obstructions from inside the printer. Paper has not been loaded correctly. Remove paper from the tray and reload it correctly. There is too much paper in the tray. Remove excess paper from the tray. The paper is too thick. Use only paper that meets the specifications required by the printer. See "Selecting print media" on page 17.
The paper keeps jamming.	<ul style="list-style-type: none"> There is too much paper in the tray. Remove excess paper from the tray. If you are printing on special materials, load only one size of print media at a time in the tray. An incorrect type of paper is being used. Use only paper that meets the specifications required by the printer. See "Specifications on print media" on page 18. There may be debris inside the printer. Open the front cover and remove the debris.
Envelopes skew or fail to feed correctly.	Ensure the paper guides are against both sides of the envelopes.

Printing problems

CONDITION	POSSIBLE CAUSE	SUGGESTED SOLUTIONS
The printer does not print.	The printer is not receiving power.	Check the power cord connections. Check the power switch and the power source.
	The printer is not selected as the default printer.	Select Dell 1230c as your default printer in your Windows.
	Check the printer for the following: <ul style="list-style-type: none"> The front cover is not closed. Close the cover. Paper is jammed. Clear the paper jam. See "Clearing paper jams" on page 31. No paper is loaded. Load paper. See "Changing the size of the paper in the paper tray" on page 20. The toner cartridge is not installed. Install the toner cartridge. If a system error occurs, contact your service representative. 	
	The connection cable between the computer and the printer is not connected properly.	Disconnect the printer cable and reconnect it.
	The connection cable between the computer and the printer is defective.	If possible, attach the cable to another computer that is working properly and print a job. You can also try using a different printer cable.
	The port setting is incorrect.	Check the Windows printer setting to ensure that the print job is sent to the correct port. If the computer has more than one port, ensure that the printer is attached to the correct one.
	The printer may be configured incorrectly.	Check the printer properties to ensure that all of the print settings are correct.
	The printer driver may be incorrectly installed.	Reinstall the printer software. See the <i>Software section</i> .
	The printer is malfunctioning.	Check the LEDs status on the control panel to see if the printer is indicating a system error.
	The printer does not print special sized paper such as a billing paper.	Paper size and paper size setting do not match.



CONDITION	POSSIBLE CAUSE	SUGGESTED SOLUTIONS
The printer selects print materials from the wrong paper source.	The paper source selection in the printer properties may be incorrect.	For many software applications, the paper source selection is found under the Thin Paper tab within the printer properties. Select the correct paper source. See the printer driver help screen.
A print job is extremely slow.	The job may be very complex.	Reduce the complexity of the page or try adjusting the print quality settings.
Half the page is blank.	The page orientation setting may be incorrect.	Change the page orientation in your application. See the printer driver help screen.
	The paper size and the paper size settings do not match.	Ensure that the paper size in the printer driver settings matches the paper in the tray. Or, ensure that the paper size in the printer driver settings matches the paper selection in the software application settings you use.
The printer prints, but the text is wrong, garbled, or incomplete.	The printer cable is loose or defective.	Disconnect the printer cable and reconnect. Try a print job that you have already printed successfully. If possible, attach the cable and the printer to another computer and try a print job that you know works. Finally, try a new printer cable.
	The wrong printer driver was selected.	Check the application's printer selection menu to ensure that your printer is selected.
	The software application is malfunctioning.	Try printing a job from another application.
	The operating system is malfunctioning.	Exit Windows and reboot the computer. Turn the printer off and then back on again.
Pages print, but are blank.	The toner cartridge is defective or out of toner.	Redistribute the toner, if necessary. See "Redistributing toner" on page 26. If necessary, replace the toner cartridge.
	The file may have blank pages.	Check the file to ensure that it does not contain blank pages.
	Some parts, such as the controller or the board, may be defective.	Contact a service representative.

CONDITION	POSSIBLE CAUSE	SUGGESTED SOLUTIONS
The printer does not print PDF file correctly. Some parts of graphics, text, or illustrations are missing.	Incompatibility between the PDF file and the Acrobat products.	Printing the PDF file as an image may solve this problem. Turn on Print As Image from the Acrobat printing options.  It will take longer to print when you print a PDF file as an image.
Your printer has an odd smell during initial use.	The oil used to protect the fuser is evaporating.	After printing about 100 color pages, there will be no more smell. It is a temporary issue.
The print quality of photos is not good. Images are not clear.	The resolution of the photo is very low.	Reduce the photo size. If you increase the photo size in the software application, the resolution will be reduced.
Before printing, the printer emits vapor near the output tray.	Using damp paper can cause vapor during printing.	This is not a problem. Just keep printing.

Printing quality problems

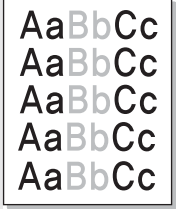
If the inside of the printer is dirty or paper has been loaded improperly, you may notice a reduction in print quality. See the table below to clear the problem.

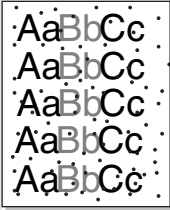
CONDITION	SUGGESTED SOLUTIONS
Light or faded print 	<p>If a vertical white streak or faded area appears on the page:</p> <ul style="list-style-type: none"> The toner supply is low. You may be able to temporarily extend the toner cartridge life. See "Replacing the toner cartridge" on page 27. If this does not improve the print quality, install a new toner cartridge. The paper may not meet paper specifications; for example, the paper is too moist or too rough. See "Selecting print media" on page 17. If the entire page is light, the print resolution setting is too low. Adjust the print resolution. See the help screen of the printer driver. A combination of faded or smeared defects may indicate that the toner cartridge needs cleaning. The surface of the LSU part inside the printer may be dirty. Clean the LSU by opening and closing the front cover several times and if the problem still occurs call the contact a service representative.

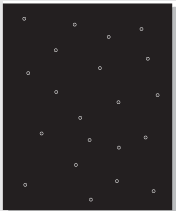
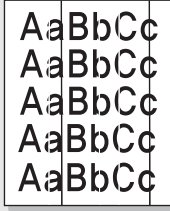
CONDITION	SUGGESTED SOLUTIONS
Toner specks 	<ul style="list-style-type: none"> The paper may not meet specifications; for example, the paper is too moist or too rough. See "Selecting print media" on page 17. The paper path may need cleaning. See "Cleaning the inside" on page 24.
Dropouts 	<p>If faded areas, generally rounded, occur randomly on the page:</p> <ul style="list-style-type: none"> A single sheet of paper may be defective. Try reprinting the job. The moisture content of the paper is uneven or the paper has moist spots on its surface. Try a different brand of paper. See "Selecting print media" on page 17. The paper lot is bad. The manufacturing processes can cause some areas to reject toner. Try a different kind or brand of paper. Change the printer option and try again. Go to printer properties, click Paper tab, and set type to Thick Paper. Refer to the <i>Software section</i> for details. <p>If these steps do not correct the problem, contact a service representative.</p>
White Spots 	<p>White spots appear on the page:</p> <ul style="list-style-type: none"> The paper is too rough and a lot of dirt from the paper falls to the inner devices within the printer, which means the transfer belt may be dirty. Clean the inside of your printer. Contact a service representative. The paper path may need cleaning. Contact a service representative.
Vertical lines 	<p>If black vertical streaks appear on the page:</p> <ul style="list-style-type: none"> The imaging unit has probably been scratched. Remove the imaging unit and install a new one. See "Replacing the Imaging Unit" on page 28. <p>If white vertical streaks appear on the page:</p> <ul style="list-style-type: none"> The surface of the LSU part inside the printer may be dirty. Clean the LSU by opening and closing the front cover several times and if the problem still occurs call the contact a service representative.

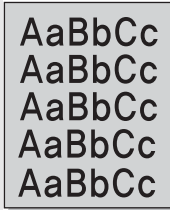
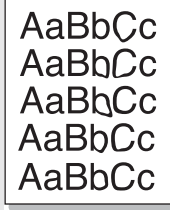
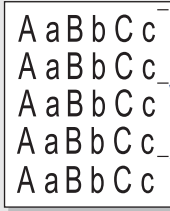
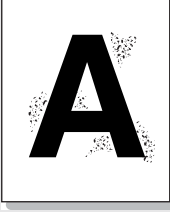
CONDITION	SUGGESTED SOLUTIONS
Color or Black background 	<p>If the amount of background shading becomes unacceptable:</p> <ul style="list-style-type: none"> Change to a lighter weight paper. See "Selecting print media" on page 17. Check the printer's environment: very dry (low humidity) or high humidity (higher than 80% RH) conditions can increase the amount of background shading. Remove the old toner cartridge and install a new one. See "Replacing the toner cartridge" on page 27.
Toner smear 	<ul style="list-style-type: none"> Clean the inside of the printer. See "Cleaning the inside" on page 24. Check the paper type and quality. See "Selecting print media" on page 17. Remove the toner cartridge and install a new one. See "Replacing the toner cartridge" on page 27.
Vertical repetitive defects 	<p>If marks repeatedly appear on the printed side of the page at even intervals:</p> <ul style="list-style-type: none"> The toner cartridge may be damaged. If a repetitive mark occurs on the page, print a cleaning sheet several times to clean the cartridge. After the printout, if you still have the same problems, remove the toner cartridge and install a new one. See "Replacing the toner cartridge" on page 27. Parts of the printer may have toner on them. If the defects occur on the back of the page, the problem will likely correct itself after a few more pages. The fusing assembly may be damaged. Contact a service representative.
Background scatter 	<p>Background scatter results from bits of toner randomly distributed on the printed page.</p> <ul style="list-style-type: none"> The paper may be too damp. Try printing with a different batch of paper. Do not open packages of paper until necessary so that the paper does not absorb too much moisture. If background scatter occurs on an envelope, change the printing layout to avoid printing over areas that have overlapping seams on the reverse side. Printing on seams can cause problems. If background scatter covers the entire surface area of a printed page, adjust the print resolution through your software application or the printer properties.

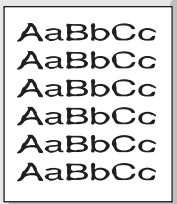
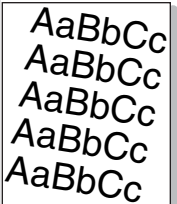
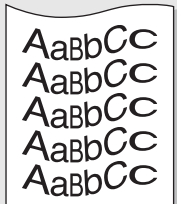
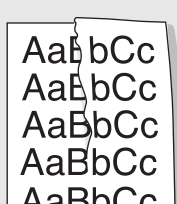
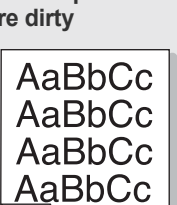
CONDITION	SUGGESTED SOLUTIONS
<p>Misformed characters</p> 	<ul style="list-style-type: none"> If characters are improperly formed and producing hollow images, the paper stock may be too slick. Try a different paper. See "Selecting print media" on page 17.
<p>Page skew</p> 	<ul style="list-style-type: none"> Ensure that the paper is loaded properly. Check the paper type and quality. See "Selecting print media" on page 17. Ensure that the paper or other material is loaded correctly and the guides are not too tight or too loose against the paper stack.
<p>Curl or wave</p> 	<ul style="list-style-type: none"> Ensure that the paper is loaded properly. Check the paper type and quality. Both high temperature and humidity can cause paper curl. See "Selecting print media" on page 17. Turn over the stack of paper in the tray. Also try rotating the paper 180° in the tray.
<p>Wrinkles or creases</p> 	<ul style="list-style-type: none"> Ensure that the paper is loaded properly. Check the paper type and quality. See "Selecting print media" on page 17. Turn over the stack of paper in the tray. Also try rotating the paper 180° in the tray.
<p>Back of printouts are dirty</p> 	<ul style="list-style-type: none"> Check for leaking toner. Clean the inside of the printer. See "Cleaning the inside" on page 24.

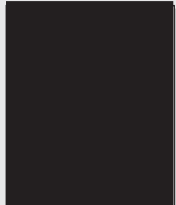
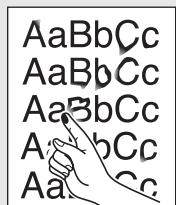
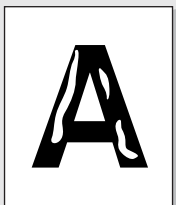
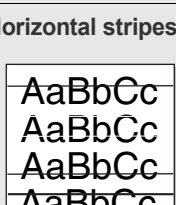
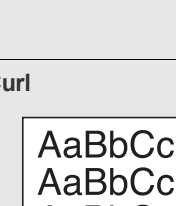
CONDITION	SUGGESTED SOLUTIONS
<p>Solid Color or Black pages</p> 	<ul style="list-style-type: none"> The toner cartridge may not be installed properly. Remove the cartridge and reinsert it. The toner cartridge may be defective and need replacing. Remove the toner cartridge and install a new one. See "Replacing the toner cartridge" on page 27. The printer may require repair. Contact a service representative.
<p>Loose toner</p> 	<ul style="list-style-type: none"> Clean the inside of the printer. See "Cleaning the inside" on page 24. Check the paper type and quality. See "Selecting print media" on page 17. Remove the toner cartridge and install a new one. See "Replacing the toner cartridge" on page 27. If the problem persists, the printer may require repair. Contact a service representative.
<p>Character Voids</p> 	<p>Character voids are white areas within parts of characters that should be solid black:</p> <ul style="list-style-type: none"> If you are using transparencies, try another type of transparency. Because of the composition of transparencies, some character voids are normal. You may be printing on the wrong surface of the paper. Remove the paper and turn it around. The paper may not meet paper specifications. See "Selecting print media" on page 17.
<p>Horizontal stripes</p> 	<p>If horizontally aligned black streaks or smears appear:</p> <ul style="list-style-type: none"> The toner cartridge may be installed improperly. Remove the cartridge and reinsert it. The toner cartridge may be defective. Remove the toner cartridge and install a new one. See "Replacing the toner cartridge" on page 27. If the problem persists, the printer may require repair. Contact a service representative.
<p>Curl</p> 	<p>If the printed paper is curled or paper does not feed into the printer:</p> <ul style="list-style-type: none"> Turn over the stack of paper in the tray. Also try rotating the paper 180° in the tray. Change the printer option and try again. Go to printer properties, click Paper tab, and set type to Thin Paper. Refer to the <i>Software section</i> for details.

CONDITION	SUGGESTED SOLUTIONS
An unknown image repetitively appears on a next few sheets or loose toner, light print, or contamination occurs.	Your printer is probably being used at an altitude of 1,000 m (3,281 ft) or above. The high altitude may affect the print quality such as loose toner or light imaging. You can set this option through Printer Settings Utility or Printer tab in printer driver's properties. See "Altitude adjustment" on page 16.

Common Windows problems

CONDITION	SUGGESTED SOLUTIONS
"File in Use" message appears during installation.	Exit all software applications. Remove all software from the StartUp Group, then restart Windows. Reinstall the printer driver.
"General Protection Fault", "Exception OE", "Spool32", or "Illegal Operation" messages appear.	Close all other applications, reboot Windows and try printing again.
"Fail To Print", "A printer timeout error occurred." messages appear.	These messages may appear during printing. Just keep waiting until the printer finishes printing. If the message appears in Ready mode or after printing has been completed, check the connection and/or whether an error has occurred.

 Refer to the Microsoft Windows documentation that came with your computer for further information on Windows error messages.

Common Macintosh problems

CONDITION	SUGGESTED SOLUTIONS
The printer does not print PDF file correctly. Some parts of graphics, text, or illustrations are missing.	Incompatibility between the PDF file and the Acrobat products: Printing the PDF file as an image may solve this problem. Turn on Print As Image from the Acrobat printing options.  It will take longer to print when you print a PDF file as an image.
The document has printed, but the print job has not disappeared from the spooler in Mac OS 10.3.2.	Update your Mac OS to OS 10.3.3. or higher.
Some letters are not displayed normally during the Cover page printing.	This problem is caused because Mac OS cannot create the font during the Cover page printing. English alphabet and numbers are displayed normally at the Cover page.

 Refer to Mac OS User's Guide that came with your computer for further information on Mac OS error messages.

ordering supplies and accessories

This chapter provides information on purchasing cartridges and accessories available for your printer.

This chapter includes:

- Supplies
- How to purchase

 The optional parts or features may differ by countries. Contact your sales representatives whether the part you want is available in your country.

SUPPLIES

When the toner runs out, you can order the following type of toner cartridge for your printer:

TYPE	AVERAGE YIELD	PART NUMBER
Standard yield^a toner cartridge	<ul style="list-style-type: none">• Average continuous black cartridge yield: 1,500 standard pages (Black)• Average continuous color cartridge yield: 1,000 standard pages (Yellow/Magenta/Cyan)	Y924J (Black) C815K (Cyan) D593K (Magenta) F479K (Yellow)
Standard yield Imaging Unit	Approx. 24,000 images ^b	C920K
Waste toner container	Approx. 10,000 images ^c	F562K

a. Declared yield value in accordance with ISO/IEC 19798.

b. Image counts based on one color on each page. If you print documents in full color (Cyan, Magenta, Yellow, Black), the life of this item will be reduced by 25%.

 When you purchase a new toner cartridge or supplies, you must purchase them in the same country you have purchased your printer. Otherwise, the toner cartridge or supplies will be incompatible with your printer since the configuration of the toner cartridge or supplies vary depending on the countries.

HOW TO PURCHASE

To order Dell-authorized supplies or accessories, contact your local Dell dealer or the retailer where you purchased your printer, or visit www.dell.com and support.dell.com and select your country/region to obtain information on calling for technical support.

specifications

This chapter guides you about this printer's specifications such as various features.

This chapter include:

- General specifications
- Printer specifications

GENERAL SPECIFICATIONS

 The symbol * optional feature depending on printers.

ITEM	DESCRIPTION	
Paper input capacity	Tray: 150 sheets for plain paper, 75 g/m ² (20 lb bond) For details about paper input capacity. See "Specifications on print media" on page 18.	
Paper output capacity	Face down: 100 sheets 75 g/m ² (20 lb bond)	
Power rating	AC 110 - 127 V or AC 220 - 240 V See the Rating label on the printer for the correct voltage, frequency (hertz) and type of current for your printer.	
Power consumption	<ul style="list-style-type: none"> • Average operating mode: Less than 350 WH • Ready mode: Less than 80 WH • Power Save mode: Less than 10 WH • Power off mode: 0 WH 	
Noise Level^a	Ready mode: Background noise level	
	Printing mode	Black & White: Less than 47 dBA Color: Less than 45 dBA
Default time to power save mode from ready mode	15 Minutes	
Warm-up time	Less than 35 seconds (Coldboot)	
Operating environment	Temperature: 10 to 32 °C (50 to 90 °F) Humidity: 20 to 80% RH	
Toner cartridge life^b	Black	Average continuous black cartridge yield: 1,500 standard pages (Shipped with 1,000 pages Starter toner cartridge.)
	Color (Yellow/Magenta/Cyan)	Average continuous color cartridge yield: 1,000 standard pages (Shipped with 700 pages Starter toner cartridge.)
Imaging Unit life	Approx. 24,000 images ^c	

ITEM	DESCRIPTION
Waste toner container	Approx. 10,000 images
Memory	32 MB (Non-extendable)
External dimension (W x D x H)	388 x 313 x 243 mm (15.3 x 12.3 x 9.6 inches)
Weight (Including consumables)	11.41 Kg (25.16 lbs)
Package weight	Paper: 1.84 Kg (4.06 lbs) Plastic: 0.26 Kg (0.57 lbs)
Duty cycle	Up to 20,000 images (Monthly)
Fusing temperature	180 °C (356 °F)

a. Sound Pressure Level, ISO 7779

b. Declared yield value in accordance with ISO/IEC 19798. The number of pages may be affected by operating environment, printing interval, media type, and media size.

c. Image counts based on one color on each page. If you print documents in full color (Black, Cyan, Magenta, Yellow), the life of this item will be reduced by 25%.

PRINTER SPECIFICATIONS

ITEM	DESCRIPTION	
Printing method	Color laser beam printing	
Printing speed ^a	<ul style="list-style-type: none">• Black and white: Up to 16 ppm (A4), 17 ppm (Letter)• Color: Up to 4 ppm (A4/Letter)	
First print out time	Black & White	From ready: Less than 14 seconds
	Color	From ready: Less than 26 seconds
Print resolution	Max. 2,400 x 600 dpi effective output	
Printer language	SPL-C	
OS compatibility ^b	<ul style="list-style-type: none">• Windows: 2000/XP/2003/Vista/2008• Macintosh: Mac OS X 10.3~10.5, Universal Mac	
Interface	High speed USB 2.0	

a. It will be affected by operating system used, computing performance, application software, connecting method, media type, media size and job complexity.

b. Visit www.dell.com and support.dell.com to download the latest software version.

glossary

 The following glossary helps you get familiar with the product by understanding the terminologies commonly used with printing as well as mentioned in this user's guide.

ADF

An Automatic Document Feeder (ADF) is a mechanism that will automatically feed an original sheet of paper so that the machine can scan some amount of the paper at once.

AppleTalk

AppleTalk is a proprietary suite of protocols developed by Apple, Inc for computer networking. It was included in the original Macintosh (1984) and is now deprecated by Apple in favor of TCP/IP networking.

BIT Depth

A computer graphics term describing the number of bits used to represent the color of a single pixel in a bitmapped image. Higher color depth gives a broader range of distinct colors. As the number of bits increases, the number of possible colors becomes impractically large for a color map. 1-bit color is commonly called as monochrome or black and white.

BMP

A bitmapped graphics format used internally by the Microsoft Windows graphics subsystem (GDI), and used commonly as a simple graphics file format on that platform.

BOOTP

Bootstrap Protocol. A network protocol used by a network client to obtain its IP address automatically. This is usually done in the bootstrap process of computers or operating systems running on them. The BOOTP servers assign the IP address from a pool of addresses to each client. BOOTP enables 'diskless workstation' computers to obtain an IP address prior to loading any advanced operating system.

CCD

Charge Coupled Device (CCD) is a hardware which enables the scan job. CCD Locking mechanism is also used to hold the CCD module to prevent any damage when you move the machine.

Collation

Collation is a process of printing a multiple-copy job in sets. When collation is selected, the device prints an entire set before printing additional copies.

Control Panel

A control panel is a flat, typically vertical, area where control or monitoring instruments are displayed. They are typically found in front of the machine.

Coverage

It is the printing term used for a toner usage measurement on printing. For example, 5% coverage means that an A4 sided paper has about 5% image or text on it. So, if the paper or original has complicated images or lots of text on it, the coverage will be higher and at the same time, a toner usage will be as much as the coverage.

CSV

Comma Separated Values (CSV). A type of file format, CSV is used to exchange data between disparate applications. The file format, as it is used in Microsoft Excel, has become a pseudo standard throughout the industry, even among non-Microsoft platforms.

DADF

A Duplex Automatic Document Feeder (DADF) is a mechanism that will automatically feed and flip over an original sheet of paper so that the machine can scan on both sides of the paper.

Default

The value or setting that is in effect when taking a printer out of its box state, reset, or initialized.

DHCP

A Dynamic Host Configuration Protocol (DHCP) is a client-server networking protocol. A DHCP server provides configuration parameters specific to the DHCP client host requesting, generally, information required by the client host to participate on an IP network. DHCP also provides a mechanism for allocation of IP addresses to client hosts.

DIMM

Dual Inline Memory Module (DIMM), a small circuit board that holds memory. DIMM stores all the data within the machine like printing data, received fax data.

DNS

The Domain Name Server (DNS) is a system that stores information associated with domain names in a distributed database on networks, such as the Internet.

Dot Matrix Printer

A dot matrix printer refers to a type of computer printer with a print head that runs back and forth on the page and prints by impact, striking an ink-soaked cloth ribbon against the paper, much like a typewriter.

DPI

Dots Per Inch (DPI) is a measurement of resolution that is used for scanning and printing. Generally, higher DPI results in a higher resolution, more visible detail in the image, and a larger file size.

DRPD

Distinctive Ring Pattern Detection. Distinctive Ring is a telephone company service which enables a user to use a single telephone line to answer several different telephone numbers.

Duplex

A mechanism that will automatically flip over a sheet of paper so that the machine can print (or scan) on both sides of the paper. A printer equipped with a Duplex can print double-sided of paper.

Duty Cycle

Duty cycle is the page quantity which does not affect printer performance for a month. Generally the printer has the lifespan limitation such as pages per year. The lifespan means the average capacity of print-outs, usually within the warranty period. For example, if the duty cycle is 48,000 pages per month assuming 20 working days, a printer limits 2,400 pages a day.

ECM

Error Correction Mode (ECM) is an optional transmission mode built into Class 1 fax machines or fax modems. It automatically detects and corrects errors in the fax transmission process that are sometimes caused by telephone line noise.

Emulation

Emulation is a technique of one machine obtaining the same results as another.

An emulator duplicates the functions of one system with a different system, so that the second system behaves like the first system. Emulation focuses on exact reproduction of external behavior, which is in contrast to simulation, which concerns an abstract model of the system being simulated, often considering its internal state.

Ethernet

Ethernet is a frame-based computer networking technology for local area networks (LANs). It defines wiring and signaling for the physical layer, and frame formats and protocols for the media access control (MAC)/data link layer of the OSI model. Ethernet is mostly standardized as IEEE 802.3. It has become the most widespread LAN technology in use during the 1990s to the present.

EtherTalk

A suite of protocols developed by Apple Computer for computer networking. It was included in the original Macintosh (1984) and is now deprecated by Apple in favor of TCP/IP networking.

FDI

Foreign Device Interface (FDI) is a card installed inside the machine to allow a third party device such as a coin operated device or a card reader. Those devices allow the pay-for-print service on your machine.

FTP

A File Transfer Protocol (FTP) is a commonly used protocol for exchanging files over any network that supports the TCP/IP protocol (such as the Internet or an intranet).

Fuser Unit

The part of a laser printer that melts the toner onto the print media. It consists of a hot roller and a back-up roller. After toner is transferred onto the paper, the fuser unit applies heat and pressure to ensure that the toner stays on the paper permanently, which is why paper is warm when it comes out of a laser printer.

Gateway

A connection between computer networks, or between a computer network and a telephone line. It is very popular, as it is a computer or a network that allows access to another computer or network.

Grayscale

A shades of gray that represent light and dark portions of an image when color images are converted to grayscale; colors are represented by various shades of gray.

Halftone

An image type that simulates grayscale by varying the number of dots. Highly colored areas consist of a large number of dots, while lighter areas consist of a smaller number of dots.

HDD

Hard Disk Drive (HDD), commonly referred to as a hard drive or hard disk, is a non-volatile storage device which stores digitally-encoded data on rapidly rotating platters with magnetic surfaces.

IEEE

The Institute of Electrical and Electronics Engineers (IEEE) is an international non-profit, professional organization for the advancement of technology related to electricity.

IEEE 1284

The 1284 parallel port standard was developed by the Institute of Electrical and Electronics Engineers (IEEE). The term "1284-B" refers to a specific connector type on the end of the parallel cable that attaches to the peripheral (for example, a printer).

Intranet

A private network that uses Internet Protocols, network connectivity, and possibly the public telecommunication system to securely share part of an organization's information or operations with its employees. Sometimes the term refers only to the most visible service, the internal website.

IP address

An Internet Protocol (IP) address is a unique number that devices use in order to identify and communicate with each other on a network utilizing the Internet Protocol standard.

IPM

The Images Per Minute (IPM) is a way of measuring the speed of a printer. An IPM rate indicates the number of single-sided sheets a printer can complete within one minute.

IPP

The Internet Printing Protocol (IPP) defines a standard protocol for printing as well as managing print jobs, media size, resolution, and so forth. IPP can be used locally or over the Internet to hundreds of printers, and also supports access control, authentication, and encryption, making it a much more capable and secure printing solution than older ones.

IPX/SPX

IPX/SPX stands for Internet Packet Exchange/Sequenced Packet Exchange. It is a networking protocol used by the Novell NetWare operating systems. IPX and SPX both provide connection services similar to TCP/IP, with the IPX protocol having similarities to IP, and SPX having similarities to TCP. IPX/SPX was primarily designed for local area networks (LANs), and is a very efficient protocol for this purpose (typically its performance exceeds that of TCP/IP on a LAN).

ISO

The International Organization for Standardization (ISO) is an international standard-setting body composed of representatives from national standards bodies. It produces world-wide industrial and commercial standards.

ITU-T

The International Telecommunication Union is an international organization established to standardize and regulate international radio and telecommunications. Its main tasks include standardization, allocation of the radio spectrum, and organizing interconnection arrangements between different countries to allow international phone calls. A -T out of ITU-T indicates telecommunication.

ITU-T No. 1 chart

Standardized test chart published by ITU-T for document facsimile transmissions.

JBIG

Joint Bi-level Image Experts Group (JBIG) is an image compression standard with no loss of accuracy or quality, which was designed for compression of binary images, particularly for faxes, but can also be used on other images.

JPEG

Joint Photographic Experts Group (JPEG) is a most commonly used standard method of lossy compression for photographic images. It is the format used for storing and transmitting photographs on the World Wide Web.

LDAP

The Lightweight Directory Access Protocol (LDAP) is a networking protocol for querying and modifying directory services running over TCP/IP.

LED

A Light-Emitting Diode (LED) is a semiconductor device that indicates the status of a machine.

MAC address

Media Access Control (MAC) address is a unique identifier associated with a network adapter. MAC address is a unique 48-bit identifier usually written as 12 hexadecimal characters grouped in pairs (e. g., 00-00-0c-34-11-4e). This address is usually hard-coded into a Network Interface Card (NIC) by its manufacturer, and used as an aid for routers trying to locate machines on large networks.

MFP

Multi Function Peripheral (MFP) is an office machine that includes the following functionality in one physical body, so as to have a printer, a copier, a fax, a scanner and etc.

MH

Modified Huffman (MH) is a compression method for decreasing the amount of data that needs to be transmitted between the fax machines to transfer the image recommended by ITU-T T.4. MH is a codebook-based run-length encoding scheme optimized to efficiently compress white space. As most faxes consist mostly of white space, this minimizes the transmission time of most faxes.

MMR

Modified Modified READ (MMR) is a compression method recommended by ITU-T T.6.

Modem

A device that modulates a carrier signal to encode digital information, and also demodulates such a carrier signal to decode transmitted information.

MR

Modified Read (MR) is a compression method recommended by ITU-T T.4. MR encodes the first scanned line using MH. The next line is compared to the first, the differences determined, and then the differences are encoded and transmitted.

NetWare

A network operating system developed by Novell, Inc. It initially used cooperative multitasking to run various services on a PC, and the network protocols were based on the archetypal Xerox XNS stack. Today NetWare supports TCP/IP as well as IPX/SPX.

OPC

Organic Photo Conductor (OPC) is a mechanism that makes a virtual image for print using a laser beam emitted from a laser printer, and it is usually green or gray colored and a cylinder shaped.

An exposing unit of a drum is slowly worn away by its usage of the printer, and it should be replaced appropriately since it gets scratches from grits of a paper.

Originals

The first example of something, such as a document, photograph or text, etc, which is copied, reproduced or translated to produce others, but which is not itself copied or derived from something else.

OSI

Open Systems Interconnection (OSI) is a model developed by the International Organization for Standardization (ISO) for communications. OSI offers a standard, modular approach to network design that divides the required set of complex functions into manageable, self-contained, functional layers. The layers are, from top to bottom, Application, Presentation, Session, Transport, Network, Data Link and Physical.

PABX

A private automatic branch exchange (PABX) is an automatic telephone switching system within a private enterprise.

PCL

Printer Command Language (PCL) is a Page Description Language (PDL) developed by HP as a printer protocol and has become an industry standard. Originally developed for early inkjet printers, PCL has been released in varying levels for thermal, matrix printer, and page printers.

PDF

Portable Document Format (PDF) is a proprietary file format developed by Adobe Systems for representing two dimensional documents in a device independent and resolution independent format.

PostScript

PostScript (PS) is a page description language and programming language used primarily in the electronic and desktop publishing areas. - that is run in an interpreter to generate an image.

Printer Driver

A program used to send commands and transfer data from the computer to the printer.

Print Media

The media like paper, envelopes, labels, and transparencies which can be used on a printer, a scanner, a fax or, a copier.

PPM

Pages Per Minute (PPM) is a method of measurement for determining how fast a printer works, meaning the number of pages a printer can produce in one minute.

PRN file

An interface for a device driver, this allows software to interact with the device driver using standard input/output system calls, which simplifies many tasks.

Protocol

A convention or standard that controls or enables the connection, communication, and data transfer between two computing endpoints.

PS

See PostScript.

PSTN

The Public-Switched Telephone Network (PSTN) is the network of the world's public circuit-switched telephone networks which, on industrial premises, is usually routed through the switchboard.

Resolution

The sharpness of an image, measured in Dots Per Inch (DPI). The higher the dpi, the greater the resolution.

SMB

Server Message Block (SMB) is a network protocol mainly applied to share files, printers, serial ports, and miscellaneous communications between nodes on a network. It also provides an authenticated Inter-process communication mechanism.

SMTP

Simple Mail Transfer Protocol (SMTP) is the standard for e-mail transmissions across the Internet. SMTP is a relatively simple, text-based protocol, where one or more recipients of a message are specified, and then the message text is transferred. It is a client-server protocol, where the client transmits an email message to the server.

Subnet Mask

The subnet mask is used in conjunction with the network address to determine which part of the address is the network address and which part is the host address.

TCP/IP

The Transmission Control Protocol (TCP) and the Internet Protocol (IP); the set of communications protocols that implement the protocol stack on which the Internet and most commercial networks run.

TCR

Transmission Confirmation Report (TCR) provides details of each transmission such as job status, transmission result and number of pages sent. This report can be set to print after each job or only after failed transmissions.

TIFF

Tagged Image File Format (TIFF) is a variable-resolution bitmapped image format. TIFF describes image data that typically come from scanners. TIFF images make use of tags, keywords defining the characteristics of the image that is included in the file. This flexible and platform-independent format can be used for pictures that have been made by various image processing applications.

Toner Cartridge

A kind of bottle within a machine like printer which contains toner. Toner is a powder used in laser printers and photocopiers, which forms the text and images on the printed paper. Toner can be melted by the heat of the fuser, causing it to bind to the fibers in the paper.

TWAIN

An industry standard for scanners and software. By using a TWAIN-compliant scanner with a TWAIN-compliant program, a scan can be initiated from within the program.; an image capture API for Microsoft Windows and Apple Macintosh operating systems.

UNC Path

Uniform Naming Convention (UNC) is a standard way to access network shares in Window NT and other Microsoft products. The format of a UNC path is: \\<servername>\<sharename>\<Additional directory>

URL

Uniform Resource Locator (URL) is the global address of documents and resources on the Internet. The first part of the address indicates what protocol to use, the second part specifies the IP address or the domain name where the resource is located.

USB

Universal Serial Bus (USB) is a standard that was developed by the USB Implementers Forum, Inc., to connect computers and peripherals. Unlike the parallel port, USB is designed to concurrently connect a single computer USB port to multiple peripherals.

Watermark

A watermark is a recognizable image or pattern in paper that appears lighter when viewed by transmitted light. Watermarks were first introduced in Bologna, Italy in 1282; they have been used by papermakers to identify their product, and also on postage stamps, currency, and other government documents to discourage counterfeiting.

WIA

Windows Imaging Architecture (WIA) is an imaging architecture that is originally introduced in Windows Me and Windows XP. A scan can be initiated from within these operating systems by using a WIA-compliant scanner.

index

A

adjustment
altitude 16

C

cleaning
inside 24
outside 24

control panel 11

D

demo page, print 14

driver
installation 15

J

jam
tips for avoiding paper jams 31

L

LED
Status 12

M

Maintenance
maintenance parts 30
toner cartridge 26

P

paper
changing the size 20
clearing jam 31
printing special materials 22

paper type
setting 22

power save mode 16

print quality problems, solve 34

printing
demo page 14
reports 24

problem, solve
paper feeding 33
printing quality 34
Windows 37

R

replacing components
toner cartridge 27

reports, print 24

S

status LED 11

stop button 11

supplies
expected toner cartridge life 26

T

toner LED 11

tray
adjusting the width and length 20

W

Windows problems 37

© 2008 Dell Inc. All rights reserved.

This user's guide is provided for information purposes only. All information included herein is subject to change without notice. Dell is not responsible for any direct or indirect damages, arising from or related to use of this user's guide.

- Dell and DELL logo are trademarks of Dell Inc.
- Microsoft, Windows, and Windows Vista are either registered trademarks or trademarks of Microsoft Corporation.
- UFST® and MicroType™ are registered trademarks of Monotype Imaging Inc.
- TrueType, LaserWriter and Macintosh are trademarks of Apple Computer, Inc.
- All other brand or product names are trademarks of their respective companies or organizations.



Software section



SOFTWARE SECTION

CONTENTS

Chapter 1: INSTALLING PRINTER SOFTWARE IN WINDOWS

Installing Printer Software	3
Installing Software for Local Printing	3
Reinstalling Printer Software	5
Removing Printer Software	6

Chapter 2: BASIC PRINTING

Printing a Document	7
Printing to a file (PRN)	8
Printer Settings	8
Layout Tab	9
Paper Tab	9
Graphics Tab	10
Extras Tab	11
About Tab	12
Printer Tab	12
Using a Favorite Setting	12
Using Help	12

Chapter 3: ADVANCED PRINTING

Printing Multiple Pages on One Sheet of Paper (N-Up Printing)	13
Printing Posters	14
Printing Booklets	14
Printing on Both Sides of Paper	15
Printing a Reduced or Enlarged Document	15
Fitting Your Document to a Selected Paper Size	15
Using Watermarks	16
Using an Existing Watermark	16

Creating a Watermark	16
Editing a Watermark	16
Deleting a Watermark	16
Using Overlays	17
What is an Overlay?	17
Creating a New Page Overlay	17
Using a Page Overlay	17
Deleting a Page Overlay	17

Chapter 4: SHARING THE PRINTER LOCALLY

Setting Up a Host Computer	18
Setting Up a Client Computer	18

Chapter 5: USING OTHER SOFTWARE

Using the Dell™ Toner Management System	19
Printer Status Monitor	19
Printer Settings Utility	19
Dell Toner Re-order application	20

Chapter 6: USING YOUR PRINTER WITH A MACINTOSH

Installing Software	21
Setting Up the Printer	21
Printing	22
Printing a Document	22
Changing Printer Settings	22
Printing Multiple Pages on One Sheet of Paper	24

1 Installing Printer Software in Windows

This chapter includes:

- **Installing Printer Software**
- **Reinstalling Printer Software**
- **Removing Printer Software**

NOTE: The following procedure is based on Windows XP, for other operating systems, refer to the corresponding Windows user's guide or online help.

Installing Printer Software

You can install the printer software for local printing. To install the printer software on the computer, perform the appropriate installation procedure depending on the printer in use.

A printer driver is software that lets your computer communicate with your printer. The procedure to install drivers may differ depending on the operating system you are using.

All applications should be closed on your PC before beginning installation.

Installing Software for Local Printing

A local printer is a printer directly attached to your computer using the printer cable supplied with your printer, such as a USB.

You can install the printer software using the typical or custom method.

NOTE: If the "New Hardware Wizard" window appears during the installation procedure, click  in the upper right corner of the box to close the window, or click **Cancel**.

Typical Installation

This is recommended for most users. All components necessary for printer operations will be installed.

- 1 Make sure that the printer is connected to your computer and powered on.
- 2 Insert the supplied CD into your CD drive.
The CD should automatically run, and an installation window appears.
If the installation window does not appear, click **Start** then click **Run**. Type **X:\Setup.exe**, replacing "X" with the letter which represents your CD drive and click **OK**.
If you use Windows Vista, click **Start** → **All programs** → **Accessories** → **Run**, and type **X:\Setup.exe**.
If the **AutoPlay** window appears in Windows Vista, click **Run Setup.exe** in **Install or run program** field, and click **Continue** in the **User Account Control** window.
- 3 Click **Next**.

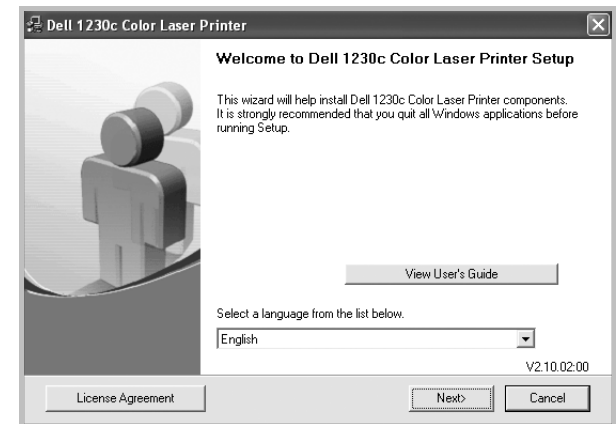

- If necessary, select a language from the drop-down list.
 - **View User's Guide:** Allows you to view the User's Guide. If your computer doesn't have Adobe Acrobat, click on this option and it will automatically install Adobe Acrobat Reader for you.
- 4 Select **Typical**. Click **Next**.

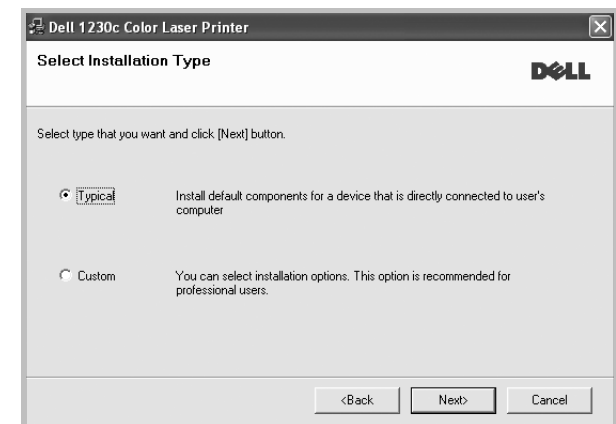

NOTE: If your printer is not already connected to the computer, the following window will appear.

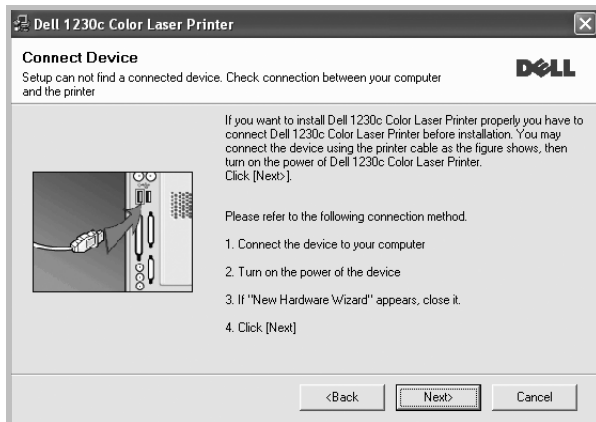

- After connecting the printer, click **Next**.
- If you don't want to connect the printer at this time, click **Next**, and **No** on the following screen. Then the installation will start and a test page will not be printed at the end of the installation.
- **The installation window that appears in this User's Guide may differ depending on the printer and interface in use.**

5 After the installation is finished, a window asking you to print a test page appears. If you choose to print a test page, select the checkbox and click **Next**. Otherwise, just click **Next** and skip to step 7.

6 If the test page prints out correctly, click **Yes**. If not, click **No** to reprint it.

7 Click **Finish**.

NOTE: After setup is complete, if your printer driver doesn't work properly, reinstall the printer driver. See "Reinstalling Printer Software" on page 5.

Custom Installation

You can choose individual components to install.

- 1** Make sure that the printer is connected to your computer and powered on.
- 2** Insert the supplied CD into your CD drive. The CD should automatically run, and an installation window appears. If the installation window does not appear, click **Start** then click **Run**. Type **X:\Setup.exe**, replacing "X" with the letter which represents your CD drive and click **OK**. If you use Windows Vista, click **Start** → **All programs** → **Accessories** → **Run**, and type **X:\Setup.exe**.

If the **AutoPlay** window appears in Windows Vista, click **Run Setup.exe** in **Install or run program** field, and click **Continue** in the **User Account Control** window.

3 Click **Next**.

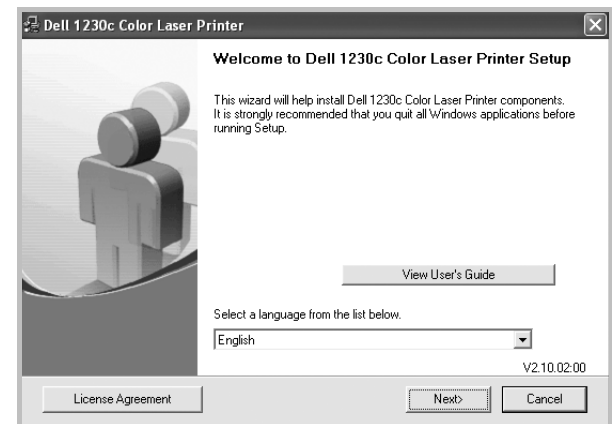

- If necessary, select a language from the drop-down list.
- **View User's Guide:** Allows you to view the User's Guide. If your computer doesn't have Adobe Acrobat, click on this option and it will automatically install Adobe Acrobat Reader for you.

4 Select **Custom**. Click **Next**.

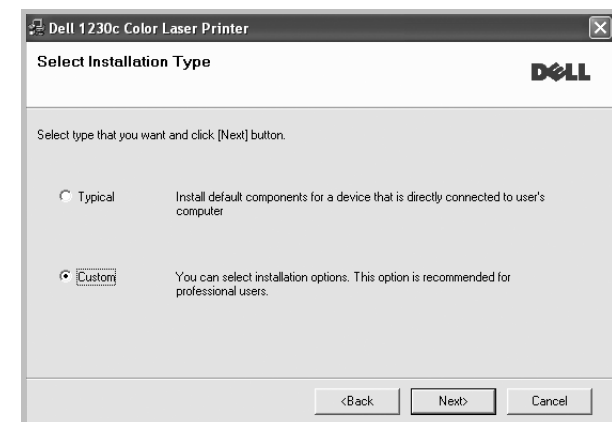

NOTE: If your printer is not already connected to the computer, the following window will appear.

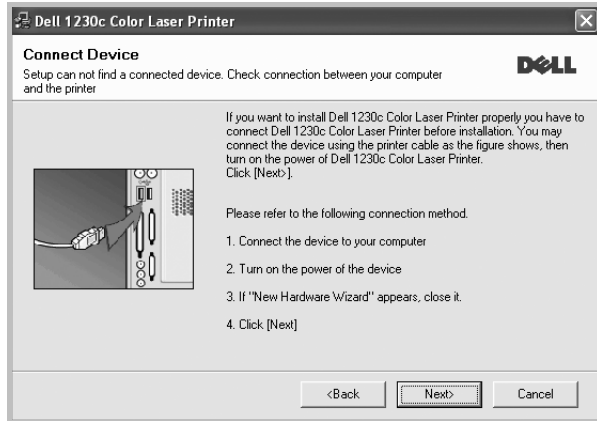

- After connecting the printer, click **Next**.
- If you don't want to connect the printer at this time, click **Next**, and **No** on the following screen. Then the installation will start and a test page will not be printed at the end of the installation.
- *The installation window that appears in this User's Guide may differ depending on the printer and interface in use.*

5 Select the components to be installed and click **Next**.

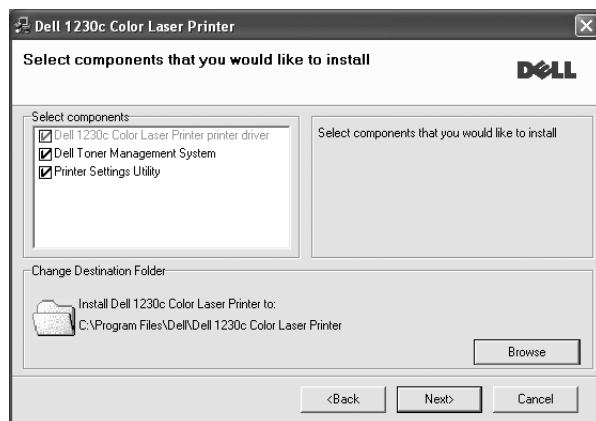

NOTE: You can change the desired installation folder by clicking [**Browse**].

- 6** After the installation is finished, a window asking you to print a test page appears. If you choose to print a test page, select the checkbox and click **Next**. Otherwise, just click **Next** and skip to step 8.
- 7** If the test page prints out correctly, click **Yes**. If not, click **No** to reprint it.
- 8** Click **Finish**.

Reinstalling Printer Software

You can reinstall the software if installation fails.

- 1** Start Windows.
- 2** From the **Start** menu select **Programs** or **All Programs** → **Dell** → **Dell Printers** → **your printer driver name** → **Maintenance**.
- 3** Select **Repair** and click **Next**.

NOTE: If your printer is not already connected to the computer, the following window will appear.

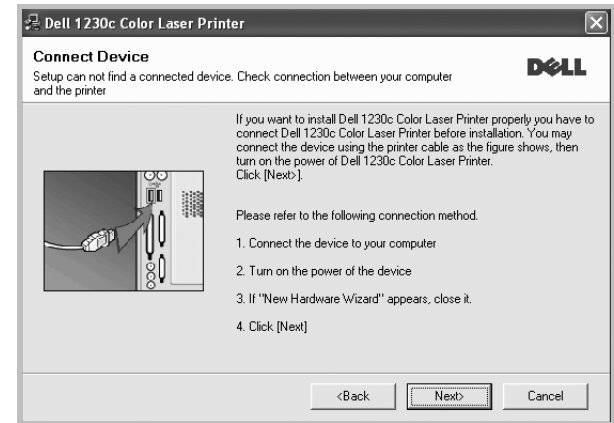

- After connecting the printer, click **Next**.
- If you don't want to connect the printer at this time, click **Next**, and **No** on the following screen. Then the installation will start and a test page will not be printed at the end of the installation.
- *The reinstallation window that appears in this User's Guide may differ depending on the printer and interface in use.*

4 Select the components you want to reinstall and click **Next**.

If you installed the printer software for local printing and you select **your printer driver name**, the window asking you to print a test page appears. Do as follows:

- To print a test page, select the check box and click **Next**.
 - If the test page prints out correctly, click **Yes**. If it doesn't, click **No** to reprint it.
- 5** When the reinstallation is done, click **Finish**.

NOTE: If you want to reinstall the driver over the currently installed driver via the provided CD, insert the CD into the CD drive. Then, the window with overwriting confirmation message appears. Simply confirm it to proceed to the next step.

Removing Printer Software

- 1 Start Windows.
- 2 From the **Start** menu select **Programs** or **All Programs** → **Dell** → **Dell Printers** → **your printer driver name** → **Maintenance**.
- 3 Select **Remove** and click **Next**.
You will see a component list so that you can remove any item individually.
- 4 Select the components you want to remove and then click **Next**.
- 5 When your computer asks you to confirm your selection, click **Yes**.
The selected driver and all of its components are removed from your computer.
- 6 After the software is removed, click **Finish**.

2 Basic Printing



This chapter explains the printing options and common printing tasks in Windows.

This chapter includes:

- **Printing a Document**
- **Printing to a file (PRN)**
- **Printer Settings**
 - **Layout Tab**
 - **Paper Tab**
 - **Graphics Tab**
 - **Extras Tab**
 - **About Tab**
 - **Printer Tab**
 - **Using a Favorite Setting**
 - **Using Help**

Printing a Document

NOTES:

- Your printer driver **Properties** window that appears in this User's Guide may differ depending on the printer in use. However the composition of the printer properties window is similar.
- **Check the Operating System(s) that are compatible with your printer. See the OS Compatibility section of Printer Specifications in your Printer User's Guide.**
- If you need to know the exact name of your printer, you can check the supplied CD-ROM.
- When you select an option in printer properties, you may see an exclamation mark  mark or a crossed-out mark . An exclamation mark means you can select that certain option but it is not recommended, and a crossed-out mark means you cannot select that option due to the machine's setting or environment.

The following procedure describes the general steps required for printing from various Windows applications. The exact steps for printing a document may vary depending on the application program you are using. Refer to the User's Guide of your software application for the exact printing procedure.

- 1 Open the document you want to print.
- 2 Select **Print** from the **File** menu. The Print window is displayed. It may look slightly different depending on your application.

The basic print settings are selected within the Print window. These settings include the number of copies and print range.

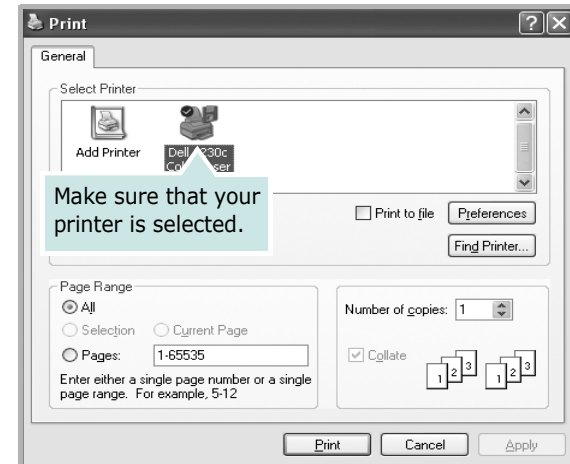

- 3 Select **your printer driver** from the **Name** drop-down list.

To take advantage of the printer features provided by your printer driver, click **Properties** or **Preferences** in the application's Print window. For details, see "Printer Settings" on page 8.

If you see **Setup, Printer, or Options** in your Print window, click it instead. Then click **Properties** on the next screen.

Click **OK** to close the printer properties window.

- 4 To start the print job, click **OK** or **Print** in the Print window.

Printing to a file (PRN)

You will sometimes need to save the print data as a file for your purpose.

To create a file:

- 1 Check the **Print to file** box at the **Print** window.

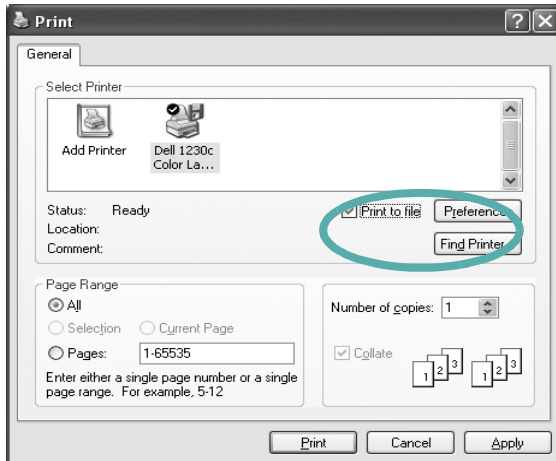

- 2 Select the folder and assign a name of the file and then click OK.

Printer Settings

You can use the printer properties window, which allows you to access all of the printer options you need when using your printer. When the printer properties are displayed, you can review and change the settings needed for your print job.

Your printer properties window may differ, depending on your operating system. This Software User's Guide shows the Properties window for Windows XP.

Your printer driver **Properties** window that appears in this User's Guide may differ depending on the printer in use.

If you access printer properties through the Printers folder, you can view additional Windows-based tabs (refer to your Windows User's Guide) and the Printer tab (see "Printer Tab" on page 12).

NOTES:

- Most Windows applications will override settings you specify in the printer driver. Change all print settings available in the software application first, and change any remaining settings using the printer driver.
- The settings you change remain in effect only while you are using the current program. **To make your changes permanent**, make them in the Printers folder.
- The following procedure is for Windows XP. For other Windows OS, refer to the corresponding Windows User's Guide or online help.
 1. Click the Windows **Start** button.
 2. Select **Printers and Faxes**.
 3. Select **your printer driver icon**.
 4. Right-click on the printer driver icon and select **Printing Preferences**.
 5. Change the settings on each tab, click OK.

Layout Tab

The **Layout** tab provides options to adjust how the document appears on the printed page. The **Layout Options** includes **Multiple Pages per Side**, **Poster Printing** and **Booklet Printing**. See "Printing a Document" on page 7 for more information on accessing printer properties.

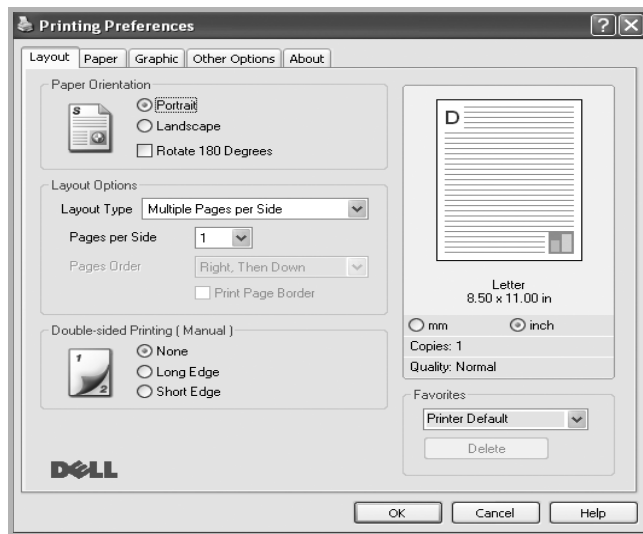

Paper Orientation

Paper Orientation allows you to select the direction in which information is printed on a page.

- **Portrait** prints across the width of the page, letter style.
- **Landscape** prints across the length of the page, spreadsheet style.
- **Rotate 180 Degrees** allows you to rotate the page, 180 degrees.

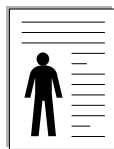

▲ Portrait

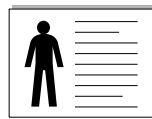

▲ Landscape

Layout Options

Layout Options allows you to select advanced printing options. You can choose **Multiple Pages per Side** and **Poster Printing**.

- For details, see "Printing Multiple Pages on One Sheet of Paper (N-Up Printing)" on page 13.
- For details, see "Printing Posters" on page 14
- For details, see "Printing Booklets" on page 14

Double-sided Printing

Double-sided Printing allows you to print on both sides of paper. **If this option does not appear, your printer does not have this feature.**

- For details, see "Printing on Both Sides of Paper" on page 15.

Paper Tab

Use the following options to set the basic paper handling specifications when you access the printer properties. See "Printing a Document" on page 7 for more information on accessing printer properties.

Click the **Paper** tab to access various paper properties.

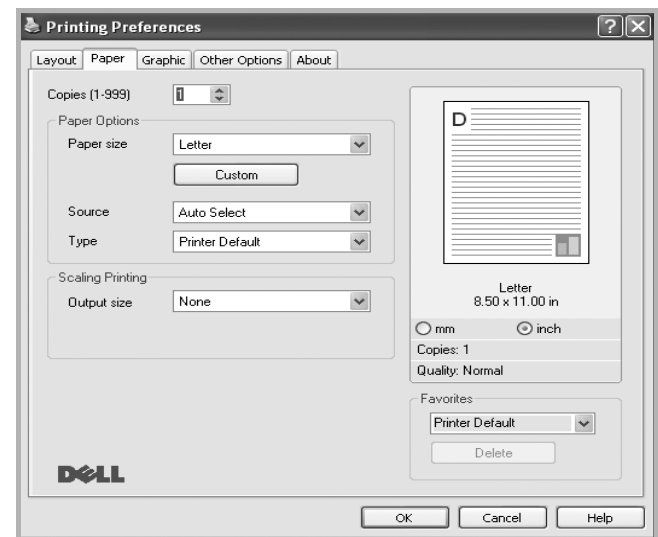

Copies

Copies allows you to choose the number of copies to be printed. You can select 1 to 999 copies.

Paper Options

Size

Size allows you to set the size of paper you loaded in the tray. If the required size is not listed in the **Size** box, click **Custom**. When the **Custom Paper Setting** window appears, set the paper size and click **OK**. The setting appears in the list so that you can select it.

Source

Make sure that **Source** is set to the corresponding paper tray. Use **Manual Feeder** when printing on special materials like envelopes and transparencies.

Type

Set **Type** to correspond to the paper loaded in the tray from which you want to print. This will let you get the best quality printout. If not, print quality may not be achieved as you want.

Thick Paper: 24 lb to 28 lb (90~105 g/m²) thick paper.

Thin Paper: 16 lb to 19 lb (60~70 g/m²) thin paper.

Cotton: 20 lb to 24 lb (75~90 g/m²) cotton paper such as Gilbert 25 % and Gilbert 100 %.

Plain Paper: Normal plain paper. Select this type if your printer is monochrome and printing on the 16 lb (60 g/m²) cotton paper.

Recycled Paper: 20 lb to 24 lb (75~90 g/m²) recycled paper.

Color Paper: 20 lb to 24 lb (75~90 g/m²) color-background paper.

Archive Paper: If you need to keep print-out for a long period time such as archives, select this option.

Glossy Photo 160 g/m² (Glossy Photo 44 lb): 44 lb (160 g/m²) glossy paper.

Scaling Printing

Scaling Printing allows you to automatically or manually scale your print job on a page. You can choose from **None**, **Reduce/Enlarge**, and **Fit to Page**.

- For details, see "Printing a Reduced or Enlarged Document" on page 15.
- For details, see "Fitting Your Document to a Selected Paper Size" on page 15.

Graphics Tab

Use the following Graphic options to adjust the print quality for your specific printing needs. See "Printing a Document" on page 7 for more information on accessing printer properties.

Click the **Graphic** tab to display the properties shown below.

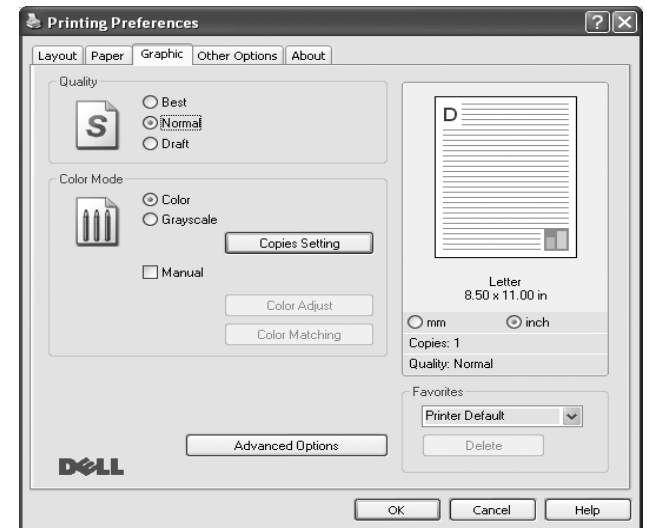

Quality

The Quality options you can select may vary depending on your printer model. The higher the setting, the sharper the clarity of printed characters and graphics. The higher setting also may increase the time it takes to print a document.

Color Mode

You can choose color options. Setting to **Color** typically produces the best possible print quality for color documents. If you want to print a color document in grayscale, select **Grayscale**. If you want to adjust the color options manually, select **Manual** and click the **Color Adjust** or **Color Matching** button.

- **Copies Setting:** In order to use this option, first you need to set total number of copies from **Paper** tab. When you make several copies, and if you want to print some copies in color and some in grayscale, use this option and select the number of copies in grayscale.
- **Color Adjust:** You can adjust the appearance of images by changing the settings in the **Levels** option.
- **Color Matching:** You can adjust the appearance of images by changing the settings in the **Settings** option.

Advanced Options

You can set advanced settings by clicking the **Advanced Options** button.

- **Print All Text To Black:** When the **Print All Text To Black** option is checked, all text in your document prints solid black, regardless of the color it appears on the screen.
- **Print All Text To Darken:** When the **Print All Text To Darken** option is checked, all text in your document is allowed to print darker than on a normal document. *Some printers do not support this feature.*
- **Grayscale Enhancement:** Press the **Smart Color** tab. It allows users to preserve the details of nature photos, and improve contrast and readability among gray scaled colors, when printing color documents in grayscale.
- **Fine Edge:** Press the **Smart Color** tab. It allows users to emphasize edges of texts and fine lines for improving readability and align each color channel registration in color printing mode.

Extras Tab

You can select output options for your document. See “Printing a Document” on page 7 for more information about accessing the printer properties.

Click the **Extras** tab to access the following feature:

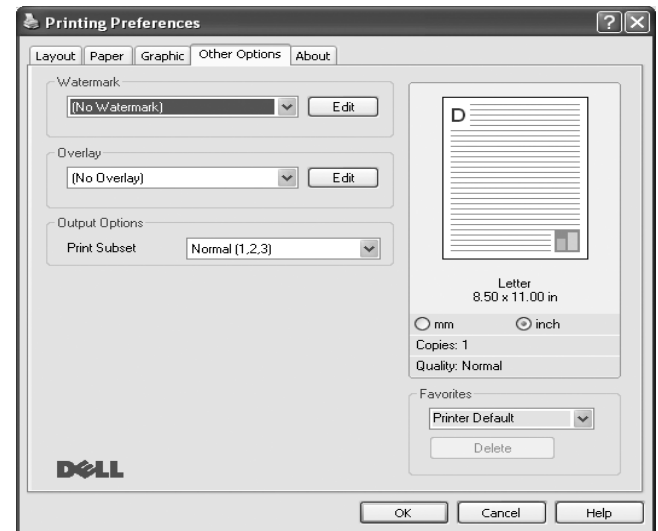

Watermark

You can create a background text image to be printed on each page of your document. For details, see “Using Watermarks” on page 16.

Overlay

Overlays are often used to take the place of preprinted forms and letterhead paper. For details, see “Using Overlays” on page 17.

Output Options

- **Print Subset:** You can set the sequence in which the pages print. Select the print order from the drop-down list.
 - **Normal (1,2,3):** Your printer prints all pages from the first page to the last page.
 - **Reverse All Pages (3,2,1):** Your printer prints all pages from the last page to the first page.
 - **Print Odd Pages:** Your printer prints only the odd numbered pages of the document.
 - **Print Even Pages:** Your printer prints only the even numbered pages of the document.

About Tab

Use the **About** tab to display the copyright notice and the version number of the driver. If you have an Internet browser, you can connect to the Internet by clicking on the web site icon. See "Printing a Document" on page 7 for more information about accessing printer properties.

Printer Tab

If you access printer properties through the **Printers** folder, you can view the **Printer** tab. You can set the printer configuration.

The following procedure is for Windows XP. For other Windows OS, refer to the corresponding Windows User's Guide or online help.

- 1 Click the Windows **Start** menu.
- 2 Select **Printers and Faxes**.
- 3 Select **your printer driver** icon.
- 4 Right-click on the printer driver icon and select **Properties**.
- 5 Click the **Printer** tab and set the options.

Using a Favorite Setting

The **Favorites** option, which is visible on each properties tab, allows you to save the current properties settings for future use.

To save a **Favorites** item:

- 1 Change the settings as needed on each tab.
- 2 Enter a name for the item in the **Favorites** input box.

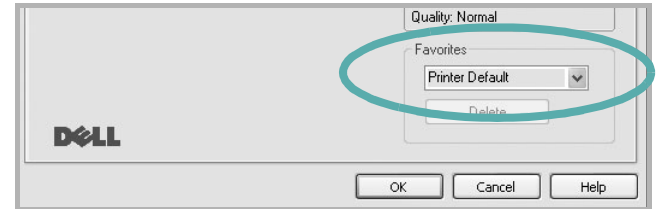

- 3 Click **Save**.

When you save **Favorites**, all current driver settings are saved.

To use a saved setting, select the item from the **Favorites** drop down list. The printer is now set to print according to the Favorites setting you selected.

To delete a Favorites item, select it from the list and click **Delete**.

You can also restore the printer driver's default settings by selecting **Printer Default** from the list.

Using Help

Your printer has a help screen that can be activated by clicking the **Help** button in the printer properties window. These help screens give detailed information about the printer features provided by the printer driver.

You can also click  from the upper right corner of the window, and then click on any setting.

3 Advanced Printing

This chapter explains printing options and advanced printing tasks.

NOTE:

- Your printer driver **Properties** window that appears in this User's Guide may differ depending on the printer in use. However the composition of the printer properties window is similar.
 - If you need to know the exact name of your printer, you can check the supplied CD-ROM.
-

This chapter includes:

- **Printing Multiple Pages on One Sheet of Paper (N-Up Printing)**
- **Printing Posters**
- **Printing Booklets**
- **Printing on Both Sides of Paper**
- **Printing a Reduced or Enlarged Document**
- **Fitting Your Document to a Selected Paper Size**
- **Using Watermarks**
- **Using Overlays**

Printing Multiple Pages on One Sheet of Paper (N-Up Printing)

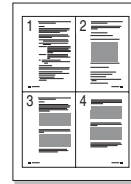

You can select the number of pages to print on a single sheet of paper. To print more than one page per sheet, the pages will be reduced in size and arranged in the order you specify. You can print up to 16 pages on one sheet.

- 1** To change the print settings from your software application, access printer properties. See "Printing a Document" on page 7.
- 2** From the **Layout** tab, choose **Multiple Pages per Side** in the **Layout Type** drop-down list.
- 3** Select the number of pages you want to print per sheet (1, 2, 4, 6, 9, or 16) in the **Pages per Side** drop-down list.
- 4** Select the page order from the **Page Order** drop-down list, if necessary.
Check **Print Page Border** to print a border around each page on the sheet.
- 5** Click the **Paper** tab, select the paper source, size, and type.
- 6** Click **OK** and print the document.

Printing Posters

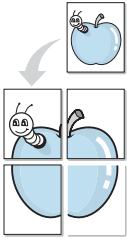

This feature allows you to print a single-page document onto 4, 9, or 16 sheets of paper, for the purpose of pasting the sheets together to form one poster-size document.

NOTE: The poster printing option is available when 600 dpi is selected in the resolution option on the Graphic tab.

- 1 To change the print settings from your software application, access printer properties. See "Printing a Document" on page 7.
- 2 Click the **Layout** tab, select **Poster Printing** in the **Layout Type** drop-down list.
- 3 Configure the poster option:

You can select the page layout from **Poster<2x2>**, **Poster<3x3>**, **Poster<4x4>** or **Custom**. If you select **Poster<2x2>**, the output will be automatically stretched to cover 4 physical pages. If the option is set to Custom, you can enlarge the original from 150% to 400%. Depending on the level of the enlargement, the page layout is automatically adjusted to **Poster<2x2>**, **Poster<3x3>**, **Poster<4x4>**.

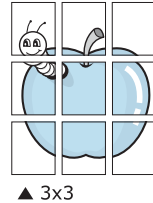
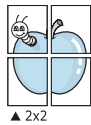

Specify an overlap in millimeters or inches to make it easier to pasting the sheets together.

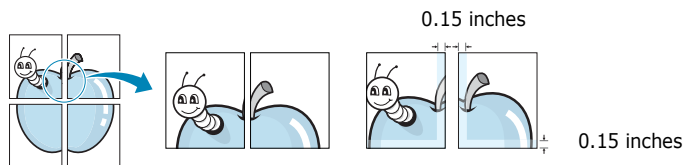

- 4 Click the **Paper** tab, select the paper source, size, and type.
- 5 Click **OK** and print the document. You can complete the poster by pasting the sheets together.

Printing Booklets

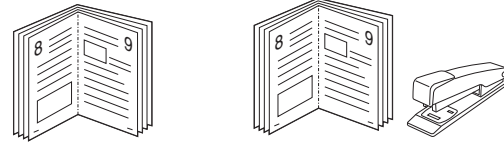

This printer feature allows you to print your document on both sides of the paper and arranges the pages so that the paper can be folded in half after printing to produce a booklet.

- 1 To change the print settings from your software application, access the printer properties. See "Printing a Document" on page 7.
- 2 From the **Layout** tab, choose **Booklet Printing** from the **Layout Type** drop-down list.

NOTE: The **Booklet Printing** option is not available for all paper sizes. In order to find out the available paper size for this feature, select the paper size in the **Size** option on the **Paper** tab, then check if the **Booklet Printing** in a **Layout Type** drop-down list on the **Layout** tab is activated.

- 3 Click the **Paper** tab, and select the paper source, size, and type.
- 4 Click **OK** and print the document.
- 5 After printing, fold and staple the pages.

Printing on Both Sides of Paper

You can print on both sides of a sheet of paper. Before printing, decide how you want your document oriented.

The options are:

- **None**
- **Long Edge**, which is the conventional layout used in book binding.
- **Short Edge**, which is the type often used with calendars.

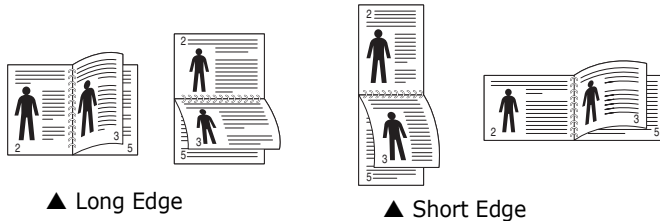

NOTE:

- Do not print on both sides of labels, transparencies, envelopes, or thick paper. Paper jamming and damage to the printer may result.

- 1 To change the print settings from your software application, access printer properties. "Printing a Document" on page 7.
- 2 From the **Layout** tab, select the paper orientation.
- 3 From the **Double-sided Printing** section, select the binding option you want.
- 4 Click the **Paper** tab and select the paper source, size, and type.
- 5 Click **OK** and print the document.

NOTE: If your printer does not have a duplex unit, you should complete the printing job manually. The printer prints every other page of the document first. After printing the first side of your job, the Printing Tip window appears. Follow the on-screen instructions to complete the printing job.

Printing a Reduced or Enlarged Document

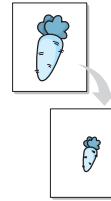

You can change the size of a page's content to appear larger or smaller on the printed page.

- 1 To change the print settings from your software application, access printer properties. See "Printing a Document" on page 7.
- 2 From the **Paper** tab, select **Reduce/Enlarge** in the **Printing Type** drop-down list.
- 3 Enter the scaling rate in the **Percentage** input box. You can also click the ▼ or ▲ button.
- 4 Select the paper source, size, and type in **Paper Options**.
- 5 Click **OK** and print the document.

Fitting Your Document to a Selected Paper Size

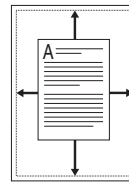

This printer feature allows you to scale your print job to any selected paper size regardless of the digital document size. This can be useful when you want to check fine details on a small document.

- 1 To change the print settings from your software application, access printer properties. See "Printing a Document" on page 7.
- 2 From the **Paper** tab, select **Fit to Page** in the **Printing Type** drop-down list.
- 3 Select the correct size from the **Output size** drop-down list.
- 4 Select the paper source, size, and type in **Paper Options**.
- 5 Click **OK** and print the document.

Using Watermarks

The Watermark option allows you to print text over an existing document. For example, you may want to have large gray letters reading "DRAFT" or "CONFIDENTIAL" printed diagonally across the first page or all pages of a document.

There are several predefined watermarks that come with the printer, and they can be modified, or you can add new ones to the list.

Using an Existing Watermark

- 1 To change the print settings from your software application, access printer properties. See "Printing a Document" on page 7.
- 2 Click the **Extras** tab, and select the desired watermark from the **Watermark** drop-down list. You will see the selected watermark in the preview image.
- 3 Click **OK** and start printing.

NOTE: The preview image shows how the page will look when it is printed.

Creating a Watermark

- 1 To change the print settings from your software application, access printer properties. See "Printing a Document" on page 7.
- 2 Click the **Extras** tab, and click the **Edit** button in the **Watermark** section. The **Edit Watermark** window appears.
- 3 Enter a text message in the **Watermark Message** box. You can enter up to 40 characters. The message displays in the preview window.
When the **First Page Only** box is checked, the watermark prints on the first page only.
- 4 Select watermark options.
You can select the font name, style, size, or grayscale level from the **Font Attributes** section and set the angle of the watermark from the **Message Angle** section.
- 5 Click **Add** to add a new watermark to the list.
- 6 When you have finished editing, click **OK** and start printing.

To stop printing the watermark, select **(No Watermark)** from the **Watermark** drop-down list.

Editing a Watermark

- 1 To change the print settings from your software application, access printer properties. See "Printing a Document" on page 7.
- 2 Click the **Extras** tab and click the **Edit** button in the **Watermark** section. The **Edit Watermark** window appears.
- 3 Select the watermark you want to edit from the **Current Watermarks** list and change the watermark message and options.
- 4 Click **Update** to save the changes.
- 5 Click **OK** until you exit the Print window.

Deleting a Watermark

- 1 To change the print settings from your software application, access printer properties. See "Printing a Document" on page 7.
- 2 From the **Extras** tab, click the **Edit** button in the Watermark section. The **Edit Watermark** window appears.
- 3 Select the watermark you want to delete from the **Current Watermarks** list and click **Delete**.
- 4 Click **OK** until you exit the Print window.

Using Overlays

What is an Overlay?



An overlay is text and/or images stored in the computer hard disk drive (HDD) as a special file format that can be printed on any document. Overlays are often used to take the place of preprinted forms and letterhead paper. Rather than using preprinted letterhead, you can create an overlay containing the exact same information that is currently on your letterhead. To print a letter with your company's letterhead, you do not need to load preprinted letterhead paper in the printer. You need only tell the printer to print the letterhead overlay on your document.

Creating a New Page Overlay

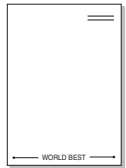

To use a page overlay, you must create a new page overlay containing your logo or image.

- 1 Create or open a document containing text or an image for use in a new page overlay. Position the items exactly as you wish them to appear when printed as an overlay.
- 2 To save the document as an overlay, access printer properties. See "Printing a Document" on page 7.
- 3 Click the **Extras** tab, and click **Edit** button in the **Overlay** section.
- 4 In the Edit Overlay window, click **Create Overlay**.
- 5 In the Create Overlay window, type a name of up to eight characters in the **File name** box. Select the destination path, if necessary. (The default is C:\Formover).
- 6 Click **Save**. The name appears on the **Overlay List** box.
- 7 Click **OK** or **Yes** to finish creating.
The file is not printed. Instead it is stored on your computer hard disk drive.

NOTE: The overlay document size must be the same as the documents you print with the overlay. Do not create an overlay with a watermark.

Using a Page Overlay

After an overlay has been created, it is ready to be printed with your document. To print an overlay with a document:

- 1 Create or open the document you want to print.
- 2 To change the print settings from your software application, access printer properties. See "Printing a Document" on page 7.
- 3 Click the **Extras** tab.
- 4 Select the desired overlay from the **Overlay** drop-down list box.
- 5 If the overlay file you want does not appear in the **Overlay** list, click **Edit** button and **Load Overlay**, and select the overlay file.

If you have stored the overlay file you want to use in an external source, you can also load the file when you access the **Load Overlay** window.

After you select the file, click **Open**. The file appears in the **Overlay List** box and is available for printing. Select the overlay from the **Overlay List** box.

- 6 If necessary, click **Confirm Page Overlay When Printing**. If this box is checked, a message window appears each time you submit a document for printing, asking you to confirm your wish to print an overlay on your document.
If this box is not checked and an overlay has been selected, the overlay automatically prints with your document.
- 7 Click **OK** or **Yes** until printing begins.
The selected overlay downloads with your print job and prints on your document.

NOTE: The resolution of the overlay document must be the same as that of the document you will print with the overlay.

Deleting a Page Overlay

You can delete page overlays that you no longer use.

- 1 In the printer properties window, click the **Extras** tab.
- 2 Click the **Edit** button in the **Overlay** section.
- 3 Select the overlay you want to delete from the **Overlay List** box.
- 4 Click **Delete Overlay**.
- 5 When a confirming message window appears, click **Yes**.
- 6 Click **OK** until you exit the Print window.

4 Sharing the Printer Locally

You can connect the printer directly to a selected computer, which is called "host computer," on the network.

The following procedure is for Windows XP. For other Windows OS, refer to the corresponding Windows User's Guide or online help.

NOTES:

- Check the Operating System(s) that are compatible with your printer. See the OS Compatibility section of Printer Specifications in your Printer User's Guide.
 - If you need to know the exact name of your printer, you can check the supplied CD-ROM.
-

Setting Up a Host Computer

- 1 Start Windows.
- 2 From the **Start** menu select **Printers and Faxes**.
- 3 Double-click **your printer driver icon**.
- 4 From the **Printer** menu, select **Sharing**.
- 5 Check the **Share this printer** box.
- 6 Fill in the **Shared Name** field, and then click **OK**.

Setting Up a Client Computer

- 1 Right-click the Windows **Start** button and select **Explore**.
- 2 Select **My Network Places** and then right-click **Search for Computers**.
- 3 Fill in the IP address of host computer in **Computer name** field, and click **Search**. (In case host computer requires **User name** and **Password**, fill in User ID and password of host computer account.)
- 4 Double-click **Printers and Faxes**.
- 5 Right-click printer driver icon, select **Connect**.
- 6 Click **Yes**, if the installation confirm message appears.

5 Using other software

Using the Dell™ Toner Management System

The printer status monitor displays the status of the printer (printer ready, printer offline, and error-check printer) and the toner level (100%, 50%, Toner Low) for your printer.

Printer Status Monitor

The printer status monitor screen launches when you send a print job to the printer. This only appears on the computer screen. Depending on the remaining toner level, the launched printer status monitor screen is different.

If you are a Windows user, from the **Start** menu, select **Programs** → **DELL** → **DELL Printers** → **your printer driver name** → **Printer Status Monitor**.

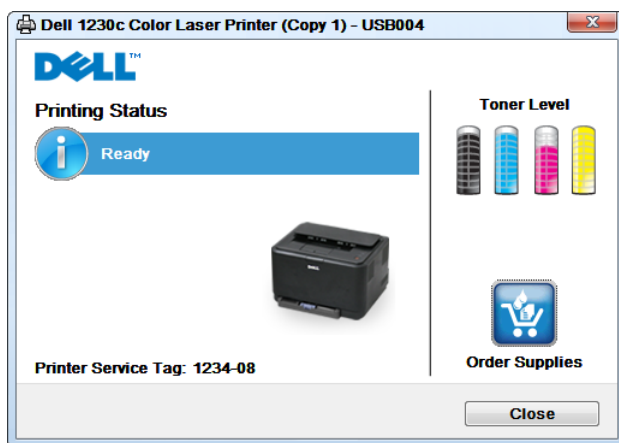

- **Printing Status:** The **Printer Status Monitor** displays the current status of the printer.
- **Toner Level:** You can view the level of toner remaining in the toner cartridge.
- **Order Supplies:** Click to order replacement toner cartridges online.
- **User's Guide:** Allows you to view the User's Guide.

Printer Settings Utility

When you install the Dell software, the Printer Settings Utility is automatically installed.

To open the Printer Settings Utility.

- 1 Click **Start** → **Programs** → **DELL** → **DELL Printers** → **your printer driver name** → **Printer Settings Utility**.

The Printer Settings Utility window opens.

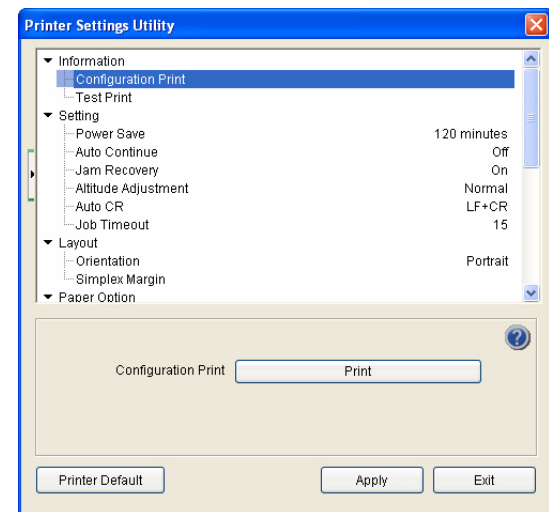

- 2 The Printer Settings Utility window provides several features.

For more information, click the  button.

To use the default settings, click the **Printer Default** button and click **Apply** button.

To exit, click the **Exit** button at the bottom of the window.

Dell Toner Re-order application

To order replacement toner cartridges or supplies from **Dell**:

- 1 Double-click the **Dell** Toner Reorder Program icon on your desktop.



OR

Click **Start** → **Programs** → **DELL** → **DELL Printers** → **your printer driver name** → **Toner Reorder**.

- 2 The **Toner Reorder** window opens.

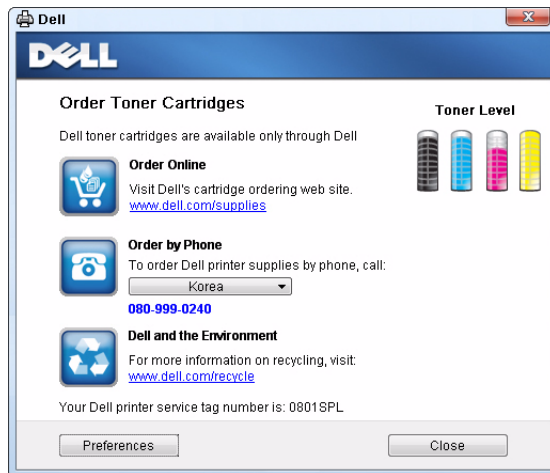

6 Using Your Printer with a Macintosh

Your printer supports Macintosh systems with a built-in USB interface. When you print a file from a Macintosh computer, you can use the CUPS driver by installing the PPD file.

This chapter includes:

- **Installing Software**
- **Setting Up the Printer**
- **Printing**

Installing Software

The CD-ROM that came with your printer provides you with the PPD file that allows you to use the driver, for printing on a Macintosh computer.

Printer driver

Installing the Printer driver

- 1 Make sure that you connect your printer to the computer. Turn on your computer and printer.
- 2 Insert the CD-ROM which came with your printer into the CD-ROM drive.
- 3 Double-click **CD-ROM icon** that appears on your Macintosh desktop.
- 4 Double-click the **MAC_Installer** folder.
- 5 Double-click the **MAC_Printer** folder.
- 6 Double-click the **Dell SPLC Installer** icon.
- 7 Enter the password and click **OK**.
- 8 The Dell SPL Installer window opens. Click **Continue** and then click **Continue**.
- 9 Select **Easy Install** and click **Install**.
- 10 After the installation is finished, click **Quit**.

Uninstalling the Printer driver

Uninstall is required if you are upgrading the software, or if installation fails.

- 1 Insert the CD-ROM which came with your printer into the CD-ROM drive.
- 2 Double-click **CD-ROM icon** that appears on your Macintosh desktop.

- 3 Double-click the **MAC_Installer** folder.
- 4 Double-click the **MAC_Printer** folder.
- 5 Double-click the **Dell SPLC Installer** icon.
- 6 Enter the password and click **OK**.
- 7 The Dell SPL Installer window opens. Click **Continue** and then click **Continue**.
- 8 Select **Uninstall** and then click **Uninstall**.
- 9 When the uninstallation is done, click **Quit**.

Setting Up the Printer

- 1 Follow the instructions on “Installing Software” on page 21 to install the PPD and Filter files on your computer.
- 2 Open the **Applications** folder → **Utilities**, and **Print Setup Utility**.
 - For MAC OS 10.5, open **System Preferences** from the **Applications** folder, and click **Printer & Fax**.
- 3 Click **Add** on the **Printer List**.
 - For MAC OS 10.5, press the “+” icon then a display window will pop up.
- 4 For MAC OS 10.3, select the **USB** tab.
 - For MAC OS 10.4, click **Default Browser** and find the USB connection.
 - For MAC OS 10.5, click **Default** and find the USB connection.
- 5 For MAC OS 10.3, if Auto Select does not work properly, select **Dell** in **Printer Model** and **your printer name** in **Model Name**.
 - For MAC OS 10.4, if Auto Select does not work properly, select **Dell** in **Print Using** and **your printer name** in **Model**.
 - For MAC OS 10.5, if Auto Select does not work properly, select **Select a driver to use...** and **your printer name** in **Print Using**.

Your machine appears on the Printer List and is set as the default printer.
- 6 Click **Add**.

Printing

NOTES:

- The Macintosh printer's properties window that appears in this User's Guide may differ depending on the printer in use. However the composition of the printer properties window is similar.
- *You can check your printer name in the supplied CD-ROM.*

Printing a Document

When you print with a Macintosh, you need to check the printer software setting in each application you use. Follow these steps to print from a Macintosh.

- 1 Open a Macintosh application and select the file you want to print.
- 2 Open the **File** menu and click **Page Setup (Document Setup** in some applications).
- 3 Choose your paper size, orientation, scaling, and other options and click **OK**.

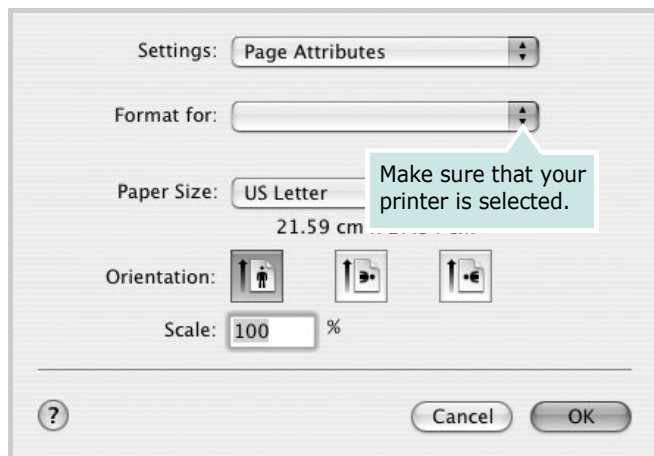

▲ Mac OS 10.3

- 4 Open the **File** menu and click **Print**.
- 5 Choose the number of copies you want and indicate which pages you want to print.
- 6 Click **Print** when you finish setting the options.

Changing Printer Settings

You can use advanced printing features when using your printer.

From your Macintosh application, select **Print** from the **File** menu. The printer name which appears in the printer properties window may differ depending on the printer in use. Except for the name, the composition of the printer properties window is similar.

NOTES: The setting options may differ depending on printers and Macintosh OS version.

Layout

The **Layout** tab provides options to adjust how the document appears on the printed page. You can print multiple pages on one sheet of paper. Select **Layout** from the **Presets** drop-down list to access the following features.

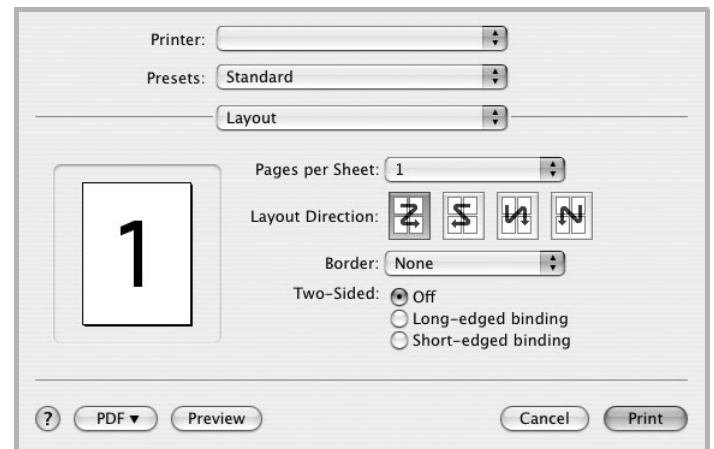

▲ Mac OS 10.4

- **Pages per Sheet:** This feature determines how many pages printed on one page. For details, see "Printing Multiple Pages on One Sheet of Paper" on the next column.
- **Layout Direction:** You can select the printing direction on a page as like the examples on UI.

Graphics

The **Graphics** tab provides options for selecting **Resolution(Quality)** and **Color Mode**. Select **Graphics** from the **Presets**' drop-down list to access the graphic features.

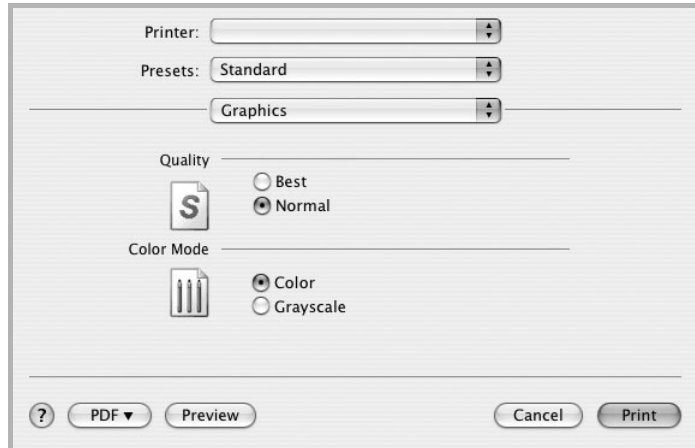

▲ Mac OS 10.4

- **Resolution(Quality)**: You can select the printing resolution. The higher the setting, the sharper the clarity of printed characters and graphics. The higher setting also may increase the time it takes to print a document.
- **Color Mode**: You can set the color options. Setting to **Color** typically produces the best possible print quality for color documents. If you want to print a color document in grayscale, select **Grayscale**.

Paper

Set **Paper Type** to correspond to the paper loaded in the tray from which you want to print. This will let you get the best quality printout. If you load a different type of print material, select the corresponding paper type.



▲ Mac OS 10.4

Printer Features

This tab provides options for selecting the paper type and adjusting print quality. Select **Printer Features** from the **Presets**' drop-down list to access the following features:



▲ Mac OS 10.4

- **Fit to Page**: This setting allows you to scale your print job to any selected paper size regardless of the digital document size. This can be useful when you want to check fine details on a small document.
- **RGB Color**: This setting determines how colors are rendered. **Standard** is the most widely used setting which the color tone of this mode is the closest to that of standard monitor (sRGB Monitor). **Vivid** mode is appropriate for printing presentation data and charts. The color tone of Vivid mode produces more **Vivid** color images than that of Standard mode. **Device** mode is best used for printing fine lines, small characters and color drawings. The color tone of **Device** mode may be different from that of monitor, the pure toner colors are used for printing Cyan, Magenta and Yellow colors.

Printing Multiple Pages on One Sheet of Paper

You can print more than one page on a single sheet of paper. This feature provides a cost-effective way to print draft pages.

- 1 From your Macintosh application, select **Print** from the **File** menu.
- 2 Select **Layout**.

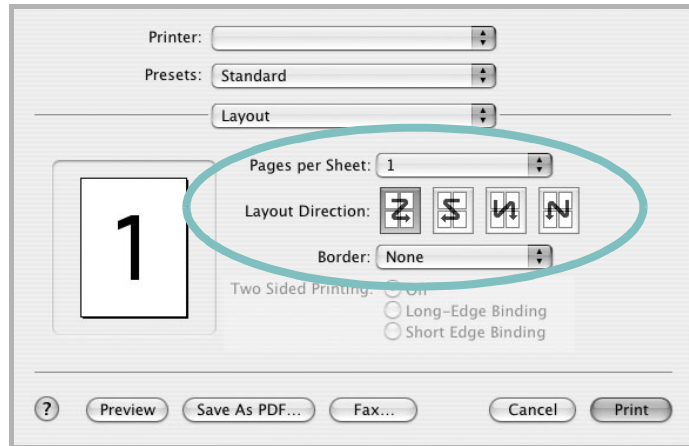

▲ Mac OS 10.3

- 3 Select the number of pages you want to print on one sheet of paper on the **Pages per Sheet** drop-down list.
- 4 Select the page order from the **Layout Direction** option. To print a border around each page on the sheet, select the option you want from the **Border** drop-down list.
- 5 Click **Print**, and the printer prints the selected number of pages on one side of each page.

SOFTWARE SECTION

INDEX

A

advanced printing, use 13

B

booklet printing 14

D

document, print
Macintosh 22
Windows 7

double-sided printing 15

E

Extras properties, set 11

F

favorites settings, use 12

G

Graphics properties, set 10

H

help, use 12

I

install
printer driver
Macintosh 21
Windows 3

L

Layout properties, set
Windows 9

M

Macintosh
driver
install 21
uninstall 21
printing 22
setting up the printer 21

N

n-up printing
Macintosh 24
Windows 13

O

orientation, print
Windows 9
overlay
create 17
delete 17
print 17

P

Paper properties, set 9
paper size, set 9
paper source, set
Windows 10
poster, print 14
print
document 7
fit to page 15
from Macintosh 22
from Windows 7
N-up
Macintosh 24
Windows 13
overlay 17
poster 16
PRN 8
scaling 15
watermark 16
printer properties, set

Macintosh 22
Windows 8
printer resolution, set
Windows 10
printer software
install
Macintosh 21
Windows 3
uninstall
Macintosh 21
Windows 6
printing
booklets 14
double-sided 15

S

setting
darkness 10
favorites 12
image mode 10
resolution
Windows 10
toner save 10
true-type option 10
software
install
Macintosh 21
Windows 3
reinstall
Windows 5
system requirements
Macintosh 21
uninstall
Macintosh 21
Windows 6
status monitor, use 19

T

toner save, set 10

U

uninstall, software
Macintosh 21

Windows 6

W

watermark
create 16
delete 16
edit 16
print 16

